

PODET C3EN_c PLAN DE COFRAJ. LUNGIME TRONSON L=1.60m /
CULVERT C3EN_c SHUTTERING PLAN. LENGTH SECTION L=1.60m

PODET C3EN_c PLAN DE ARMARE. LUNGIME TRONSON L=1.60m /
CULVERT C3EN_c REINFORCING PLAN. LENGTH SECTION L=1.60m

SECTIUNE A-A/ A-A SECTION
Scara 1:20/ Scale 1:20

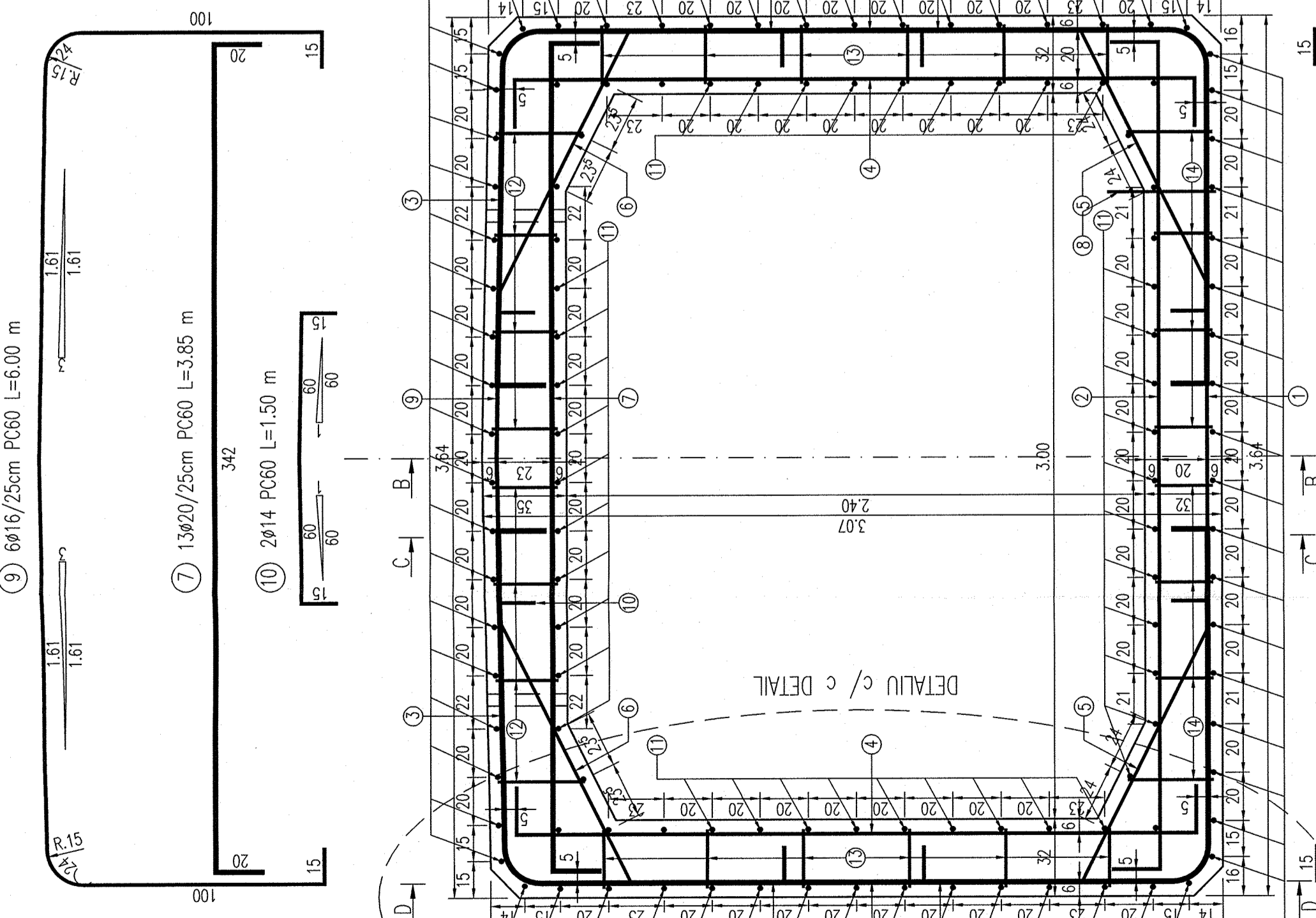

SECTIUNE a-a/ a-a SECTION
Scara 1:20/ Scale 1:20

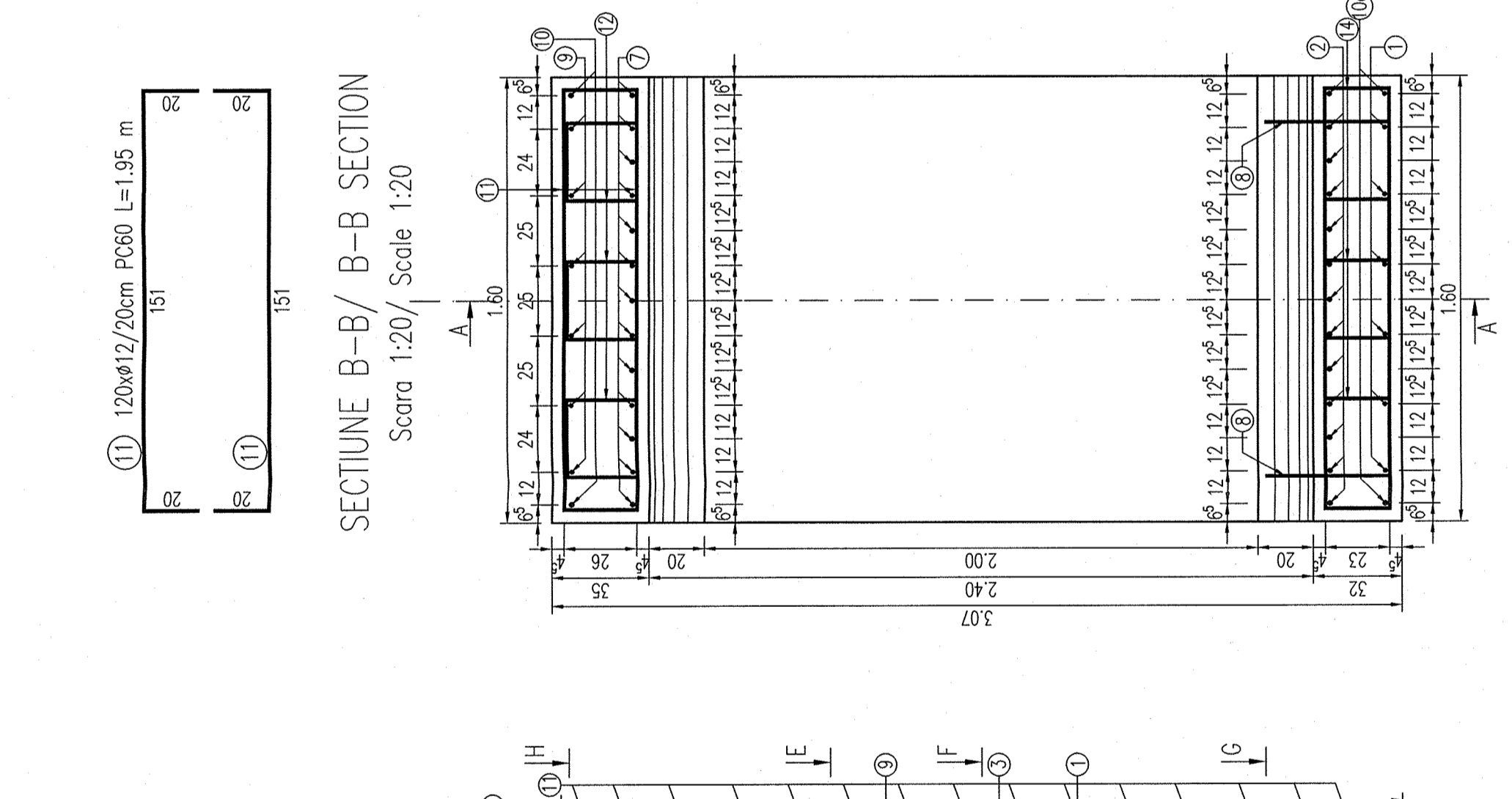

SECTIUNE B-B/ B-B SECTION
Scara 1:20/ Scale 1:20

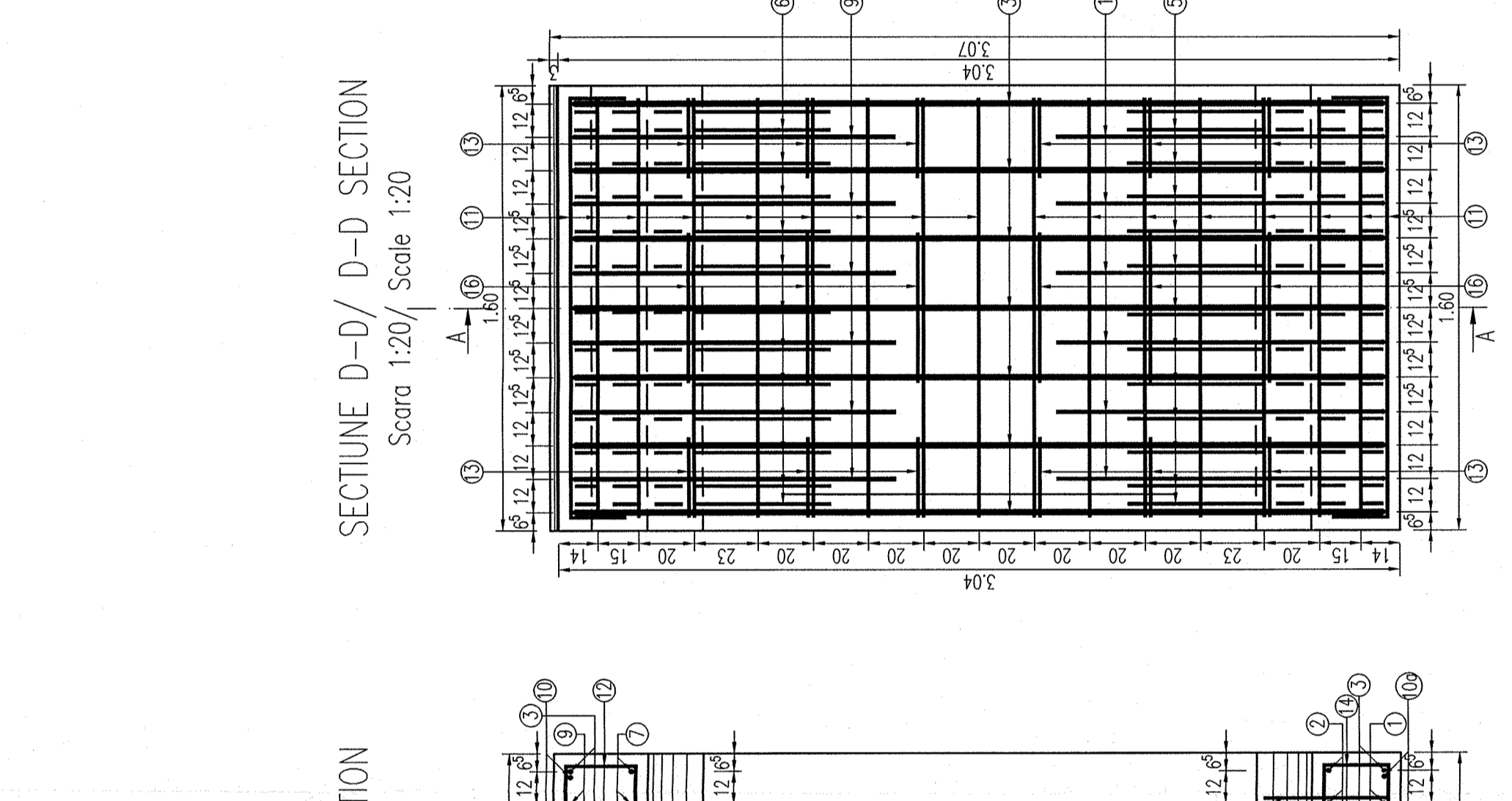

SECTIUNE C-C/ C-C SECTION
Scara 1:20/ Scale 1:20

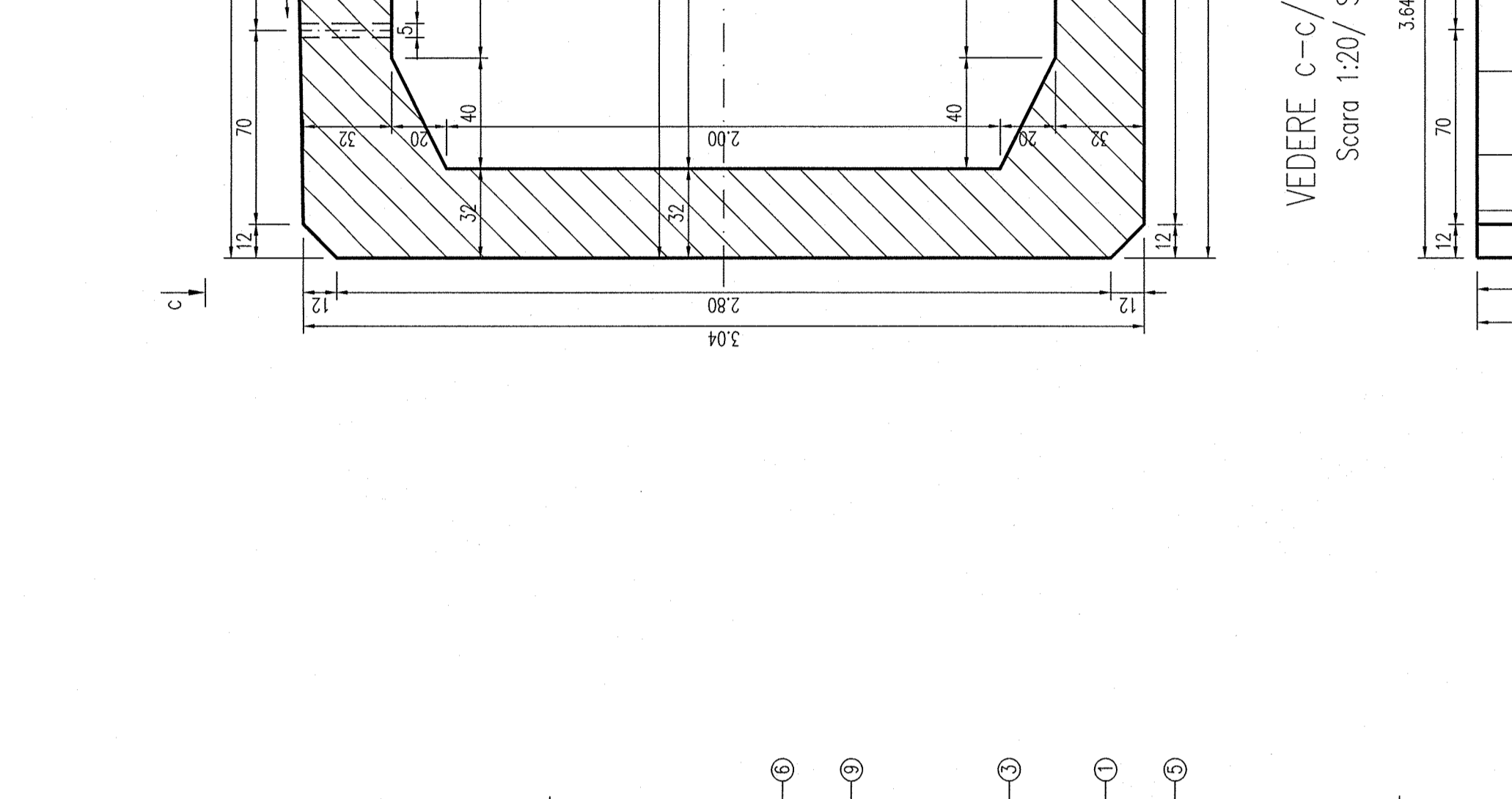

SECTIUNE D-D/ D-D SECTION
Scara 1:20/ Scale 1:20

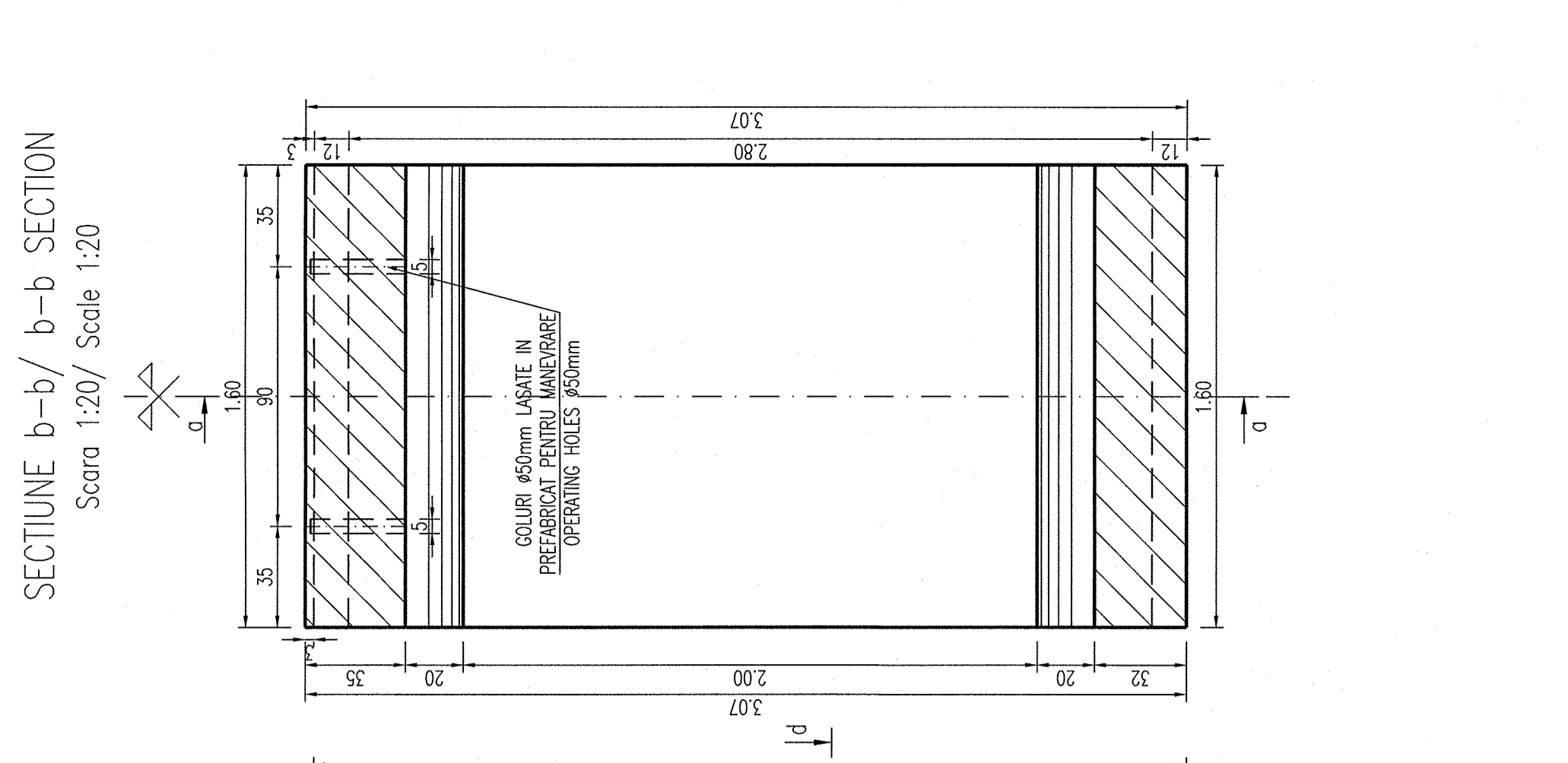

SECTIUNE e-e/ e-e SECTION
Scara 1:20/ Scale 1:20

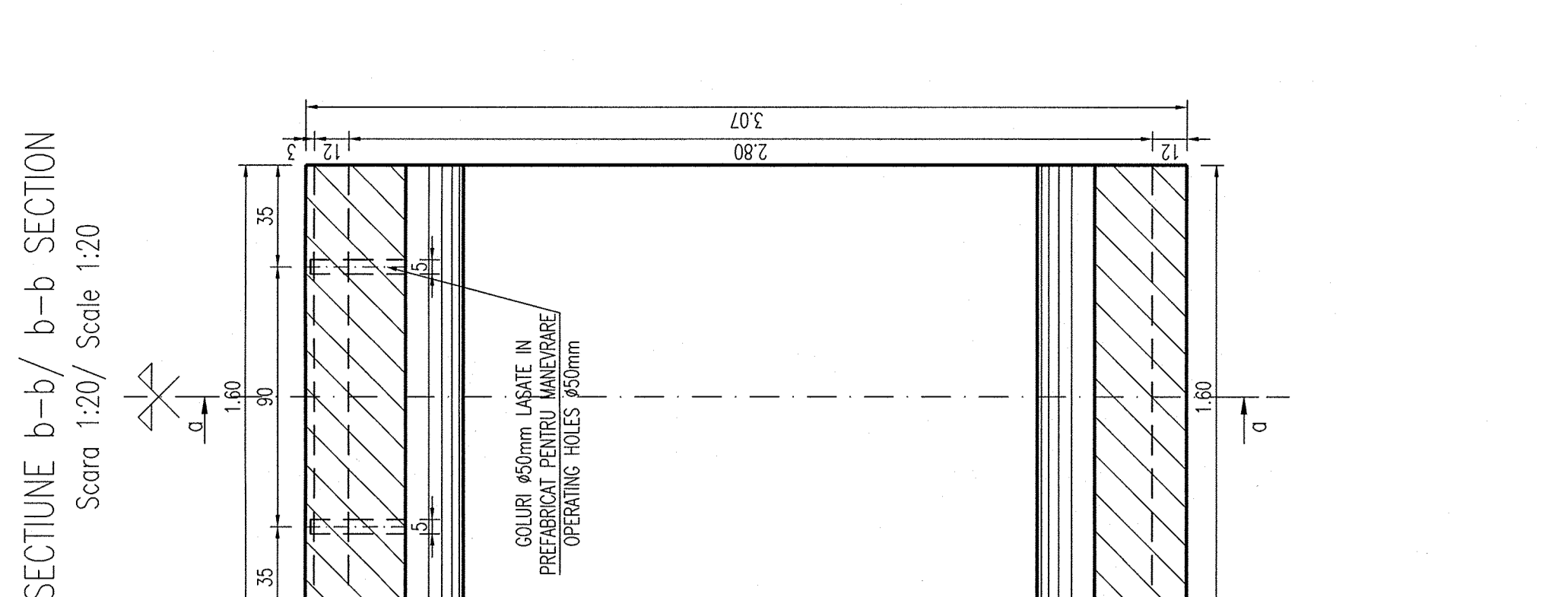

SECTIUNE f-f/ F-F SECTION
Scara 1:20/ Scale 1:20

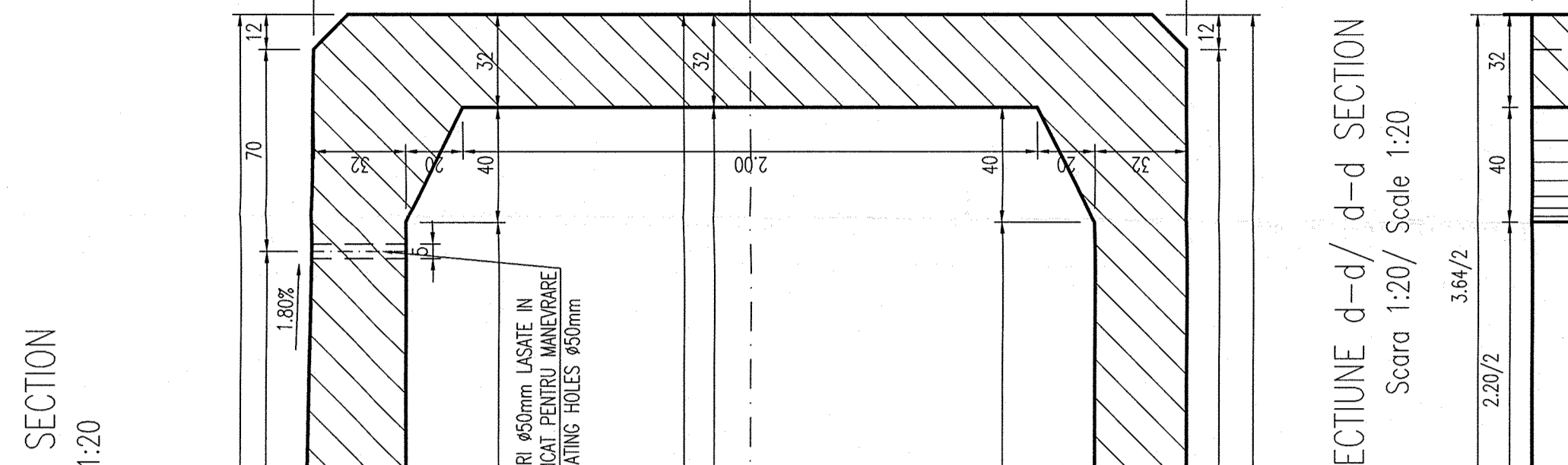

SECTIUNE g-g/ G-G SECTION
Scara 1:20/ Scale 1:20

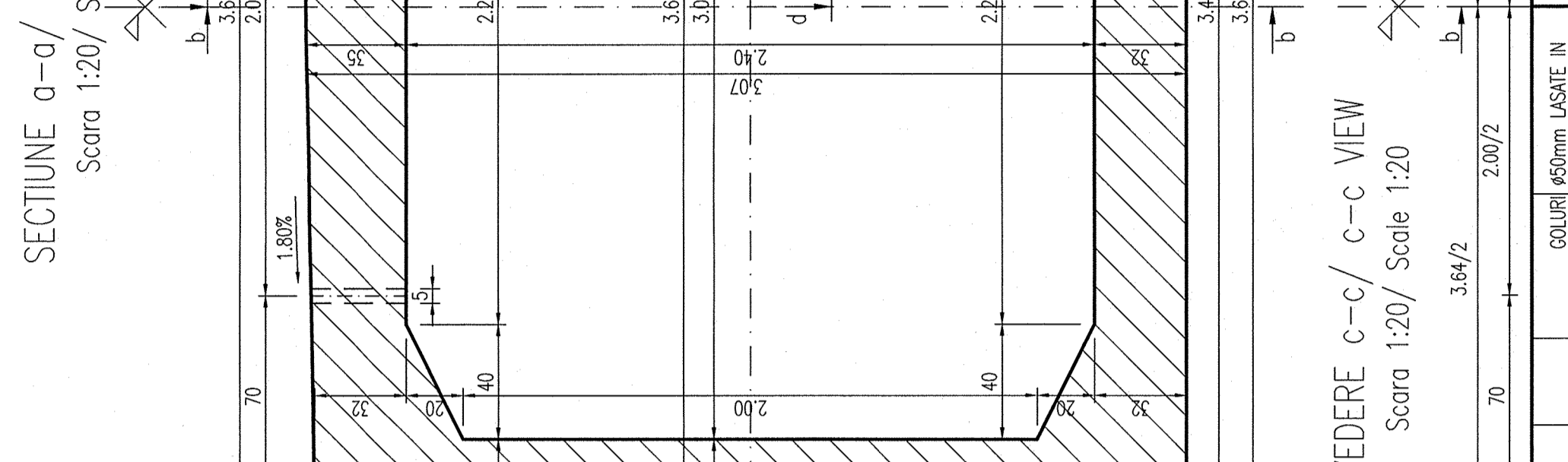

SECTIUNE h-h/ H-H SECTION
Scara 1:20/ Scale 1:20

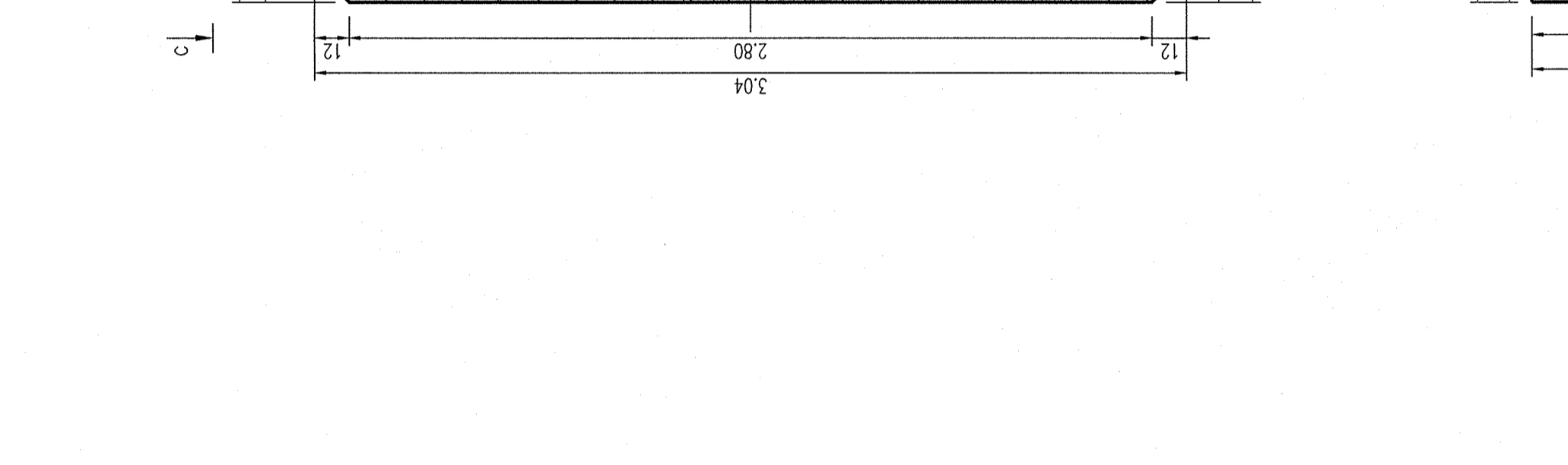

SECTIUNE i-i/ I-I SECTION
Scara 1:20/ Scale 1:20

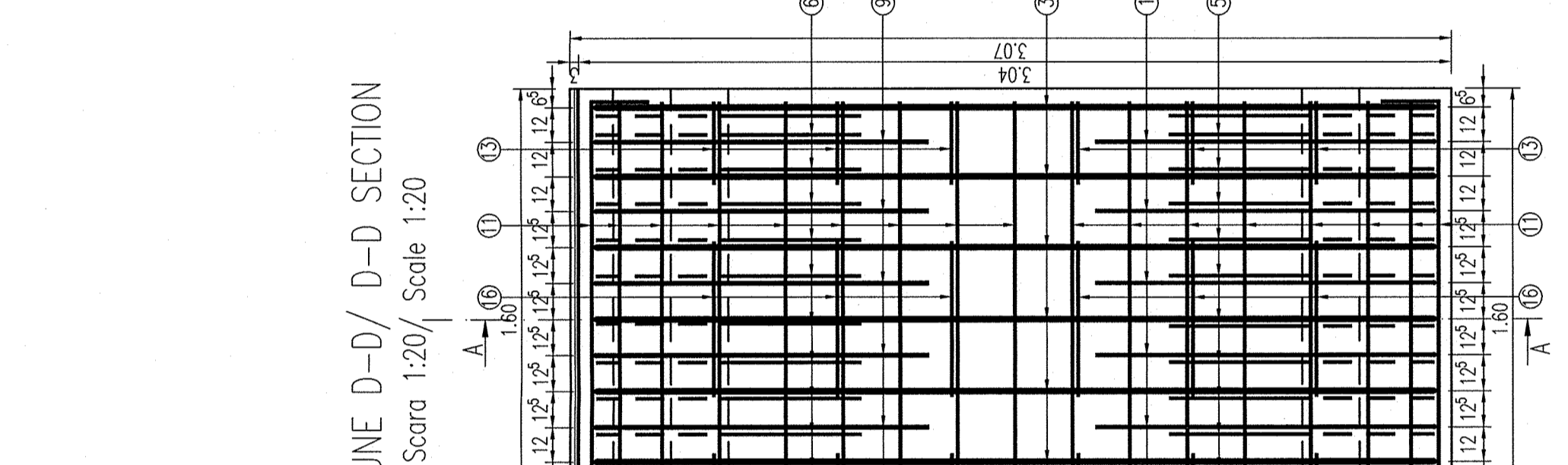

SECTIUNE j-j/ J-J SECTION
Scara 1:20/ Scale 1:20

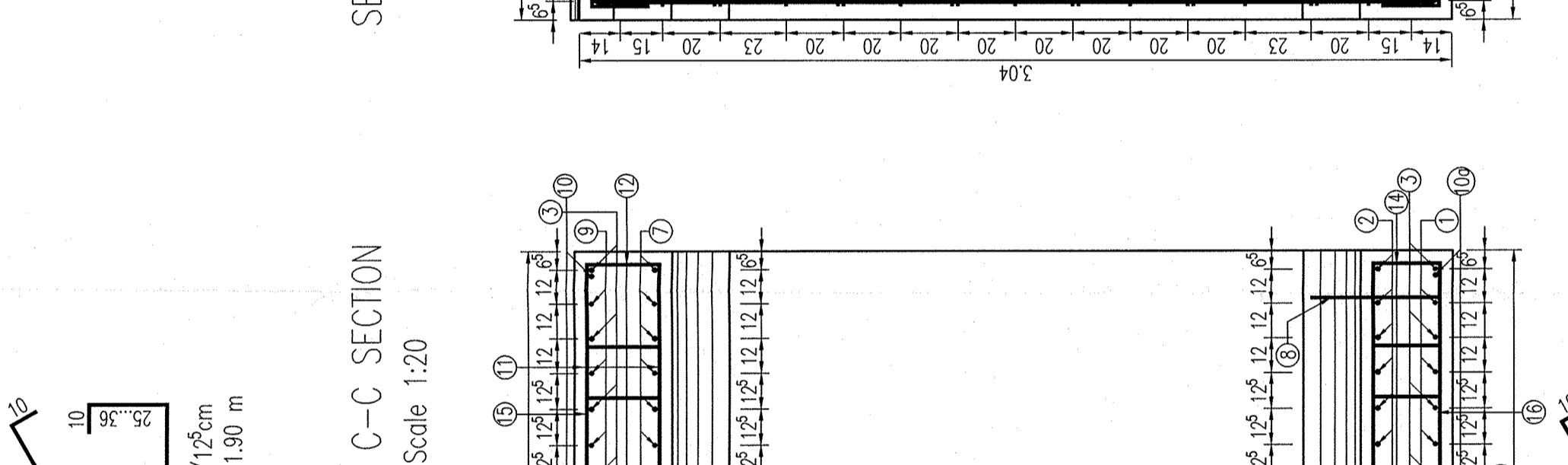

SECTIUNE k-k/ K-K SECTION
Scara 1:20/ Scale 1:20

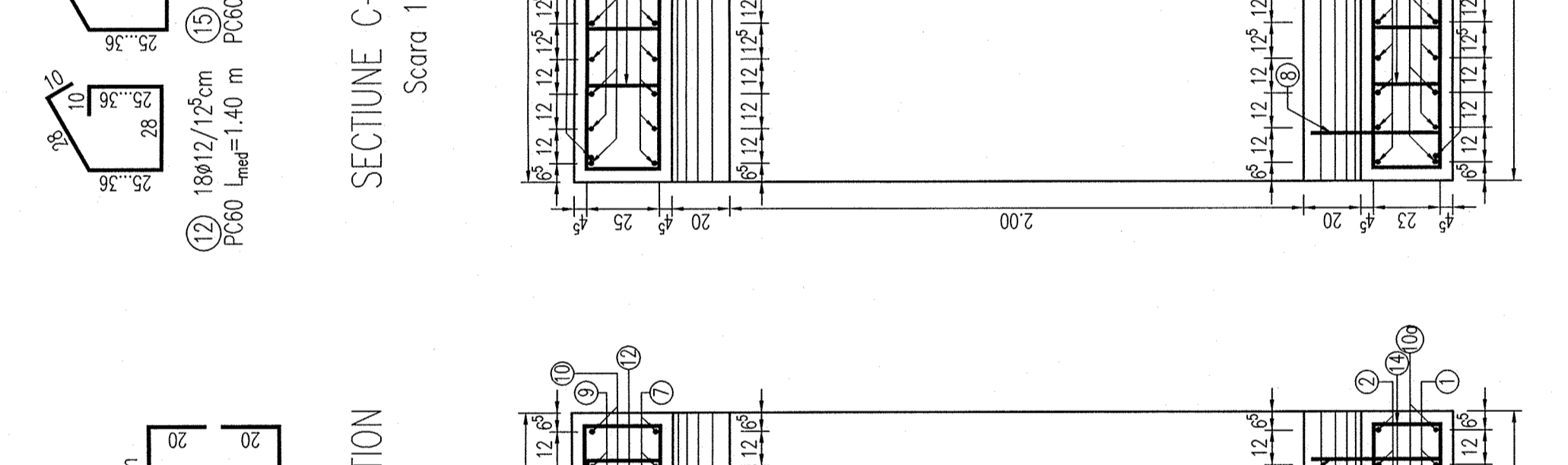

SECTIUNE l-l/ L-L SECTION
Scara 1:20/ Scale 1:20

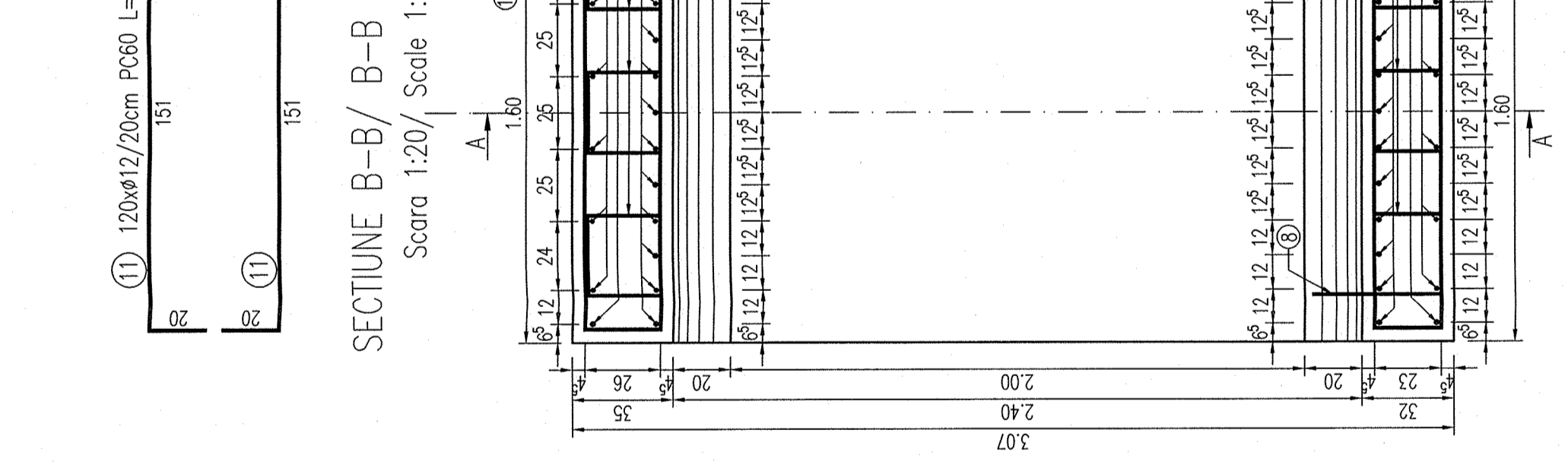

SECTIUNE m-m/ M-M SECTION
Scara 1:20/ Scale 1:20

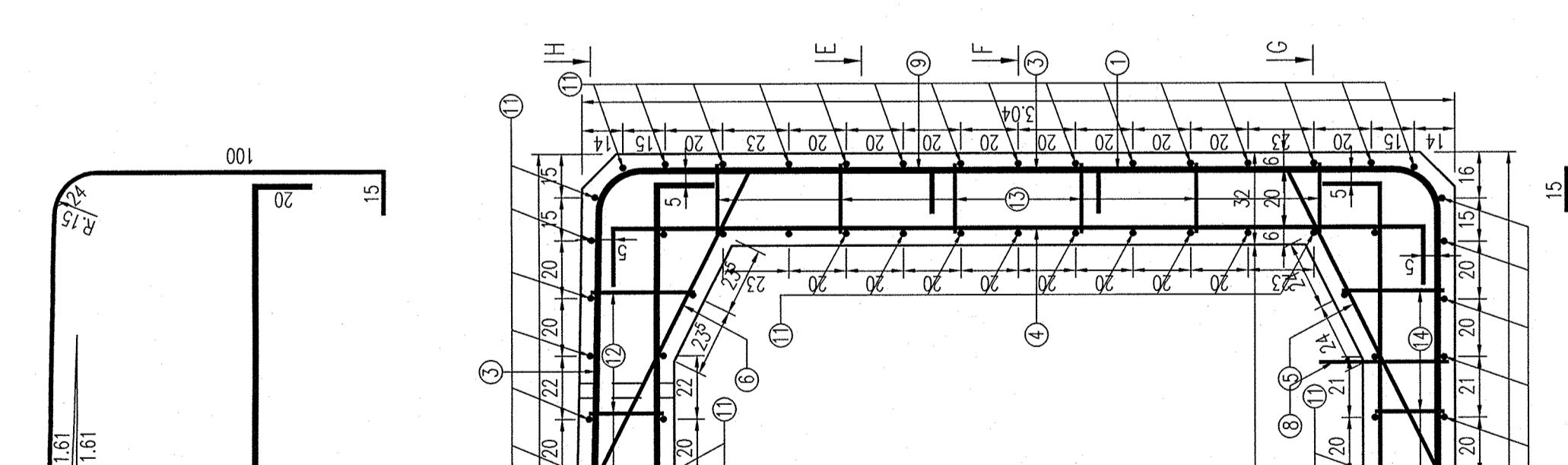

SECTIUNE n-n/ N-N SECTION
Scara 1:20/ Scale 1:20

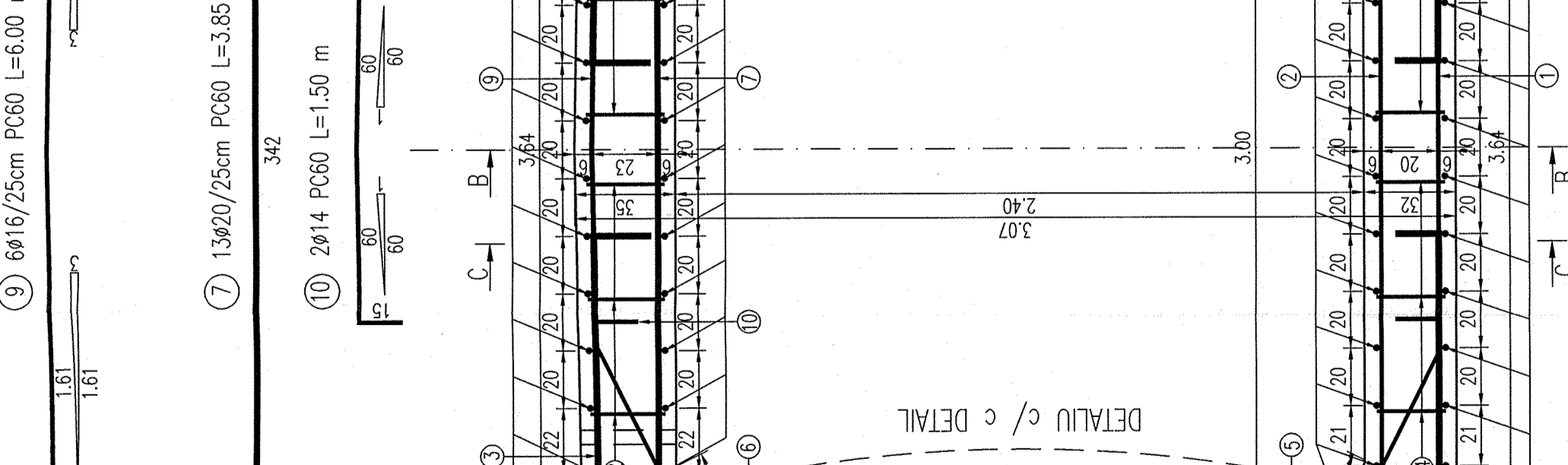

SECTIUNE o-o/ O-O SECTION
Scara 1:20/ Scale 1:20

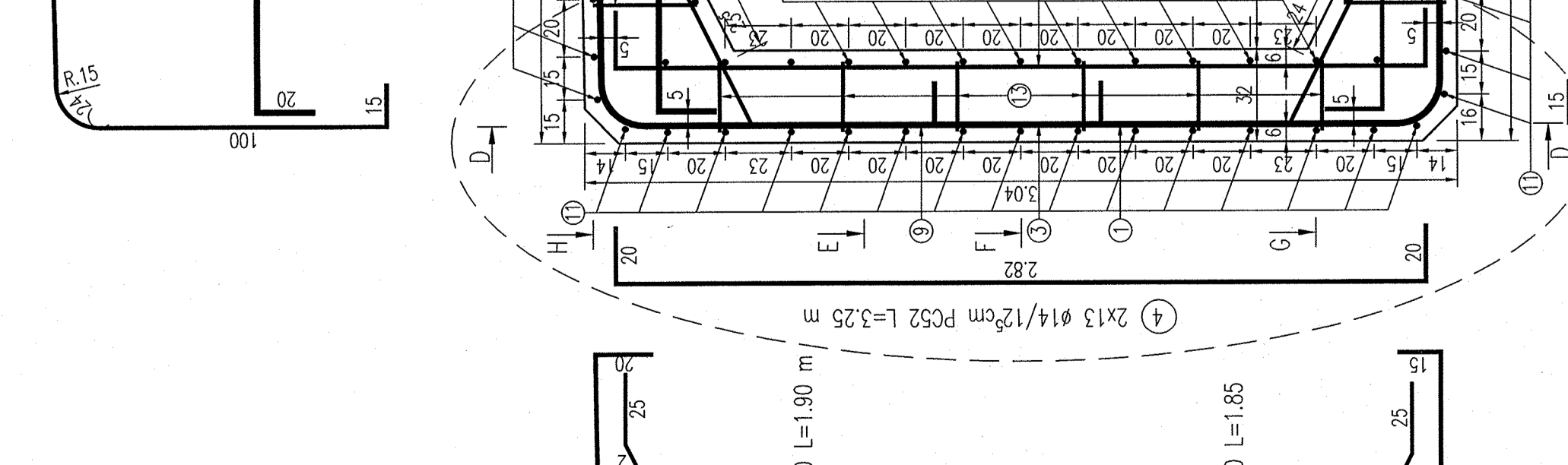

SECTIUNE p-p/ P-P SECTION
Scara 1:20/ Scale 1:20

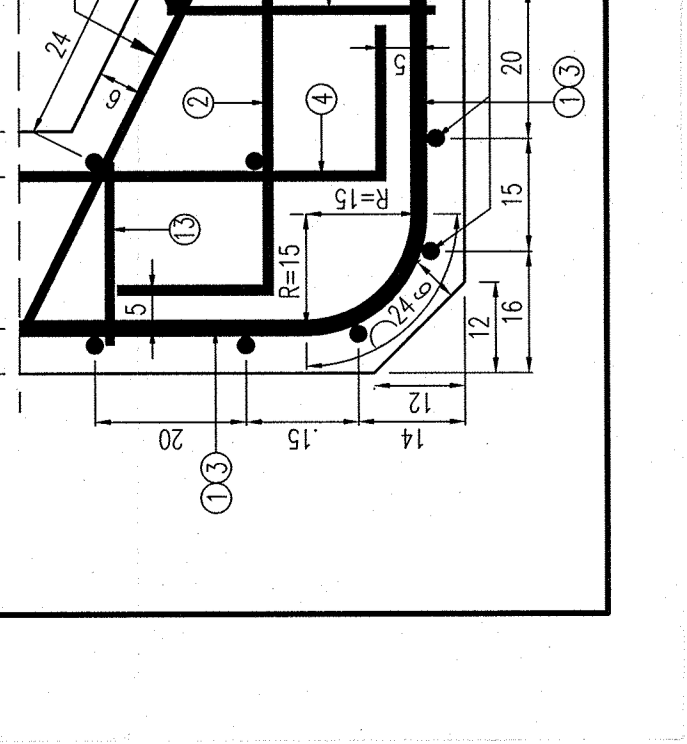
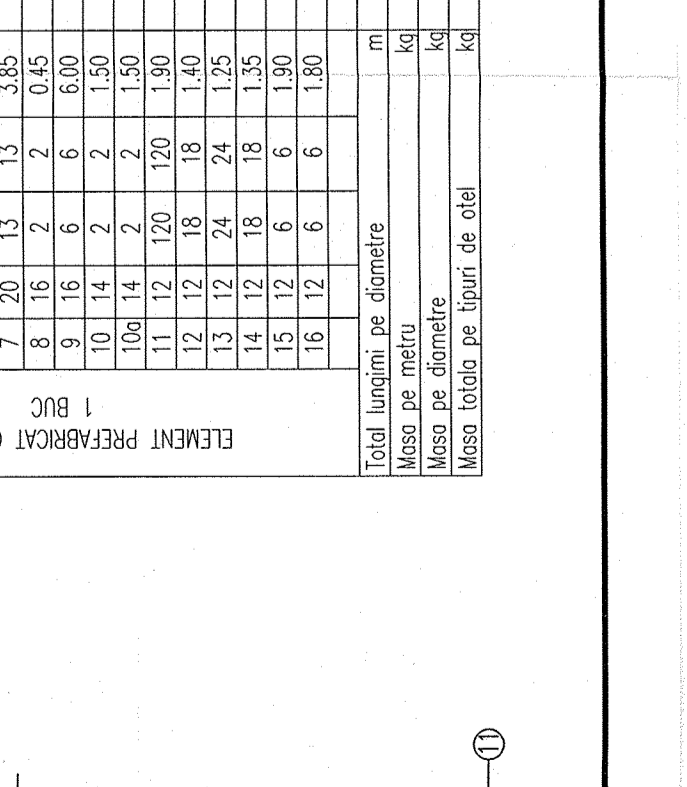
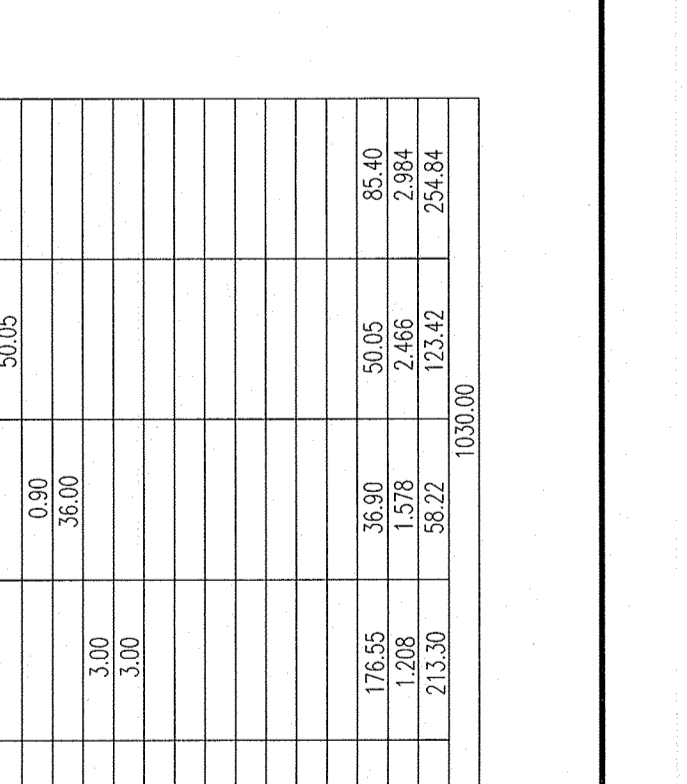
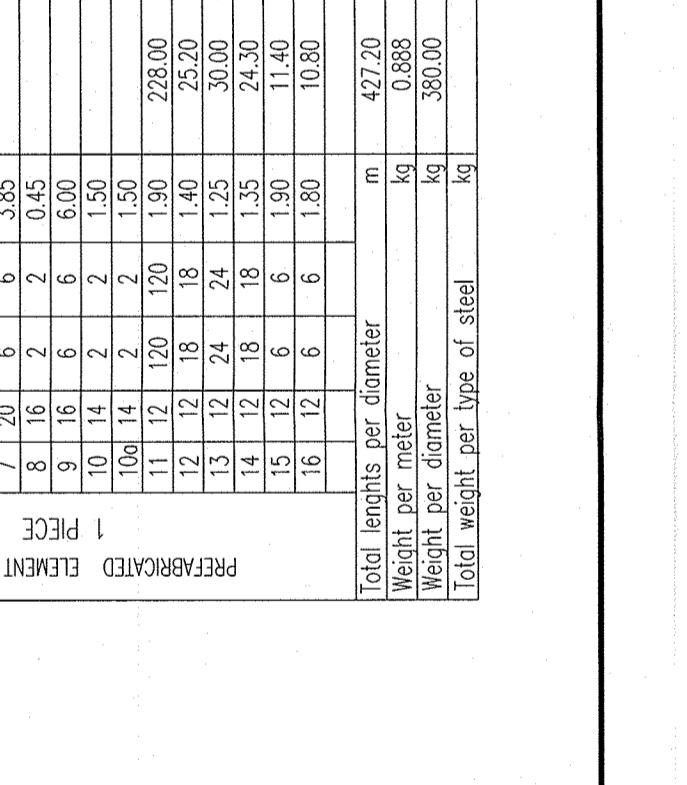
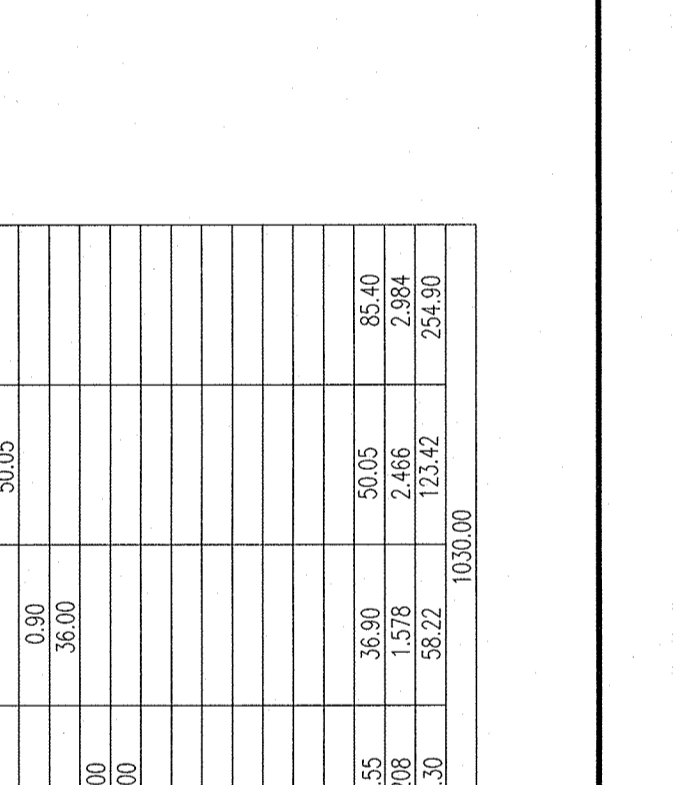
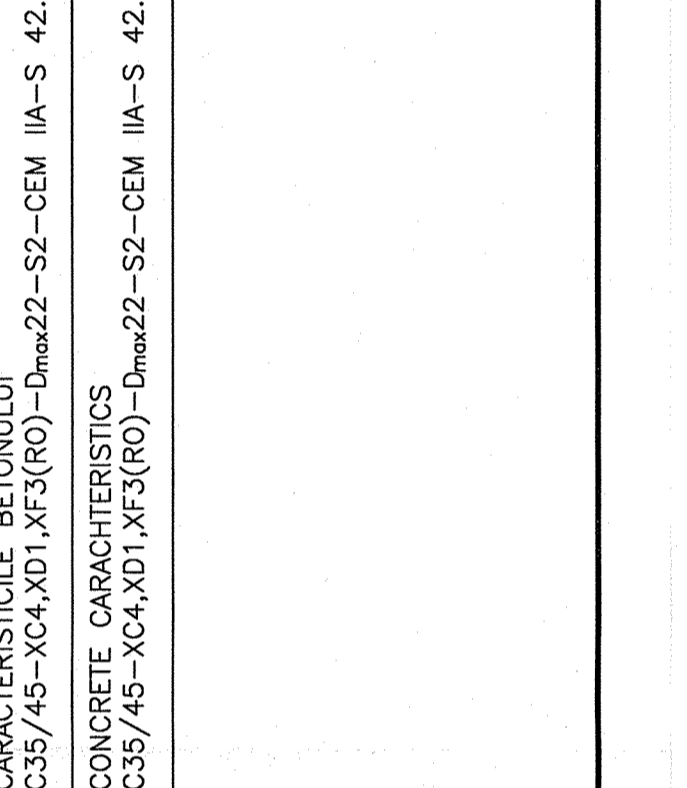
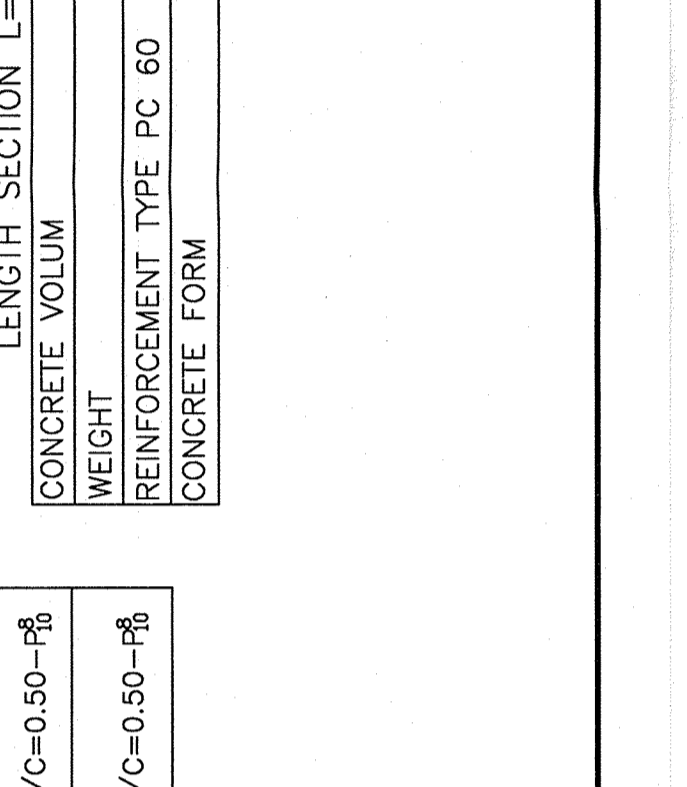
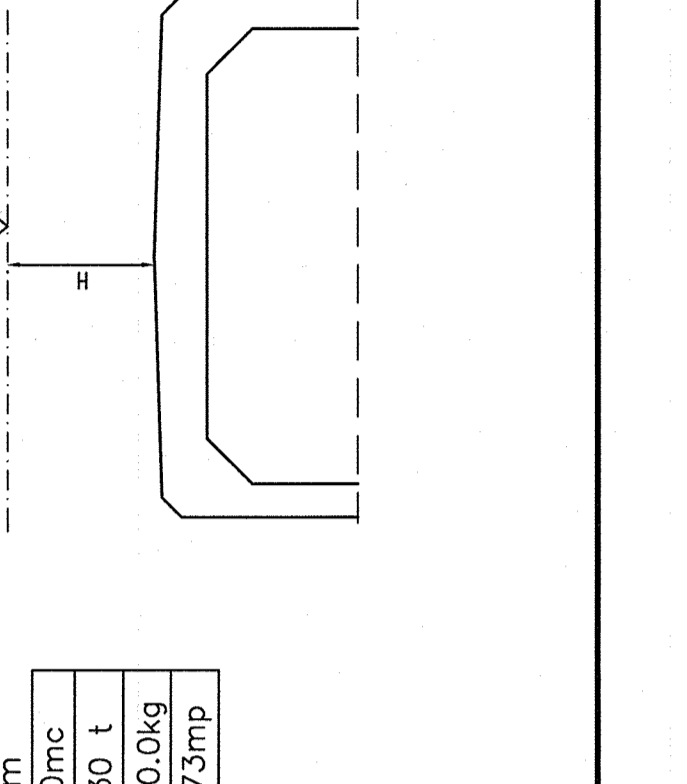
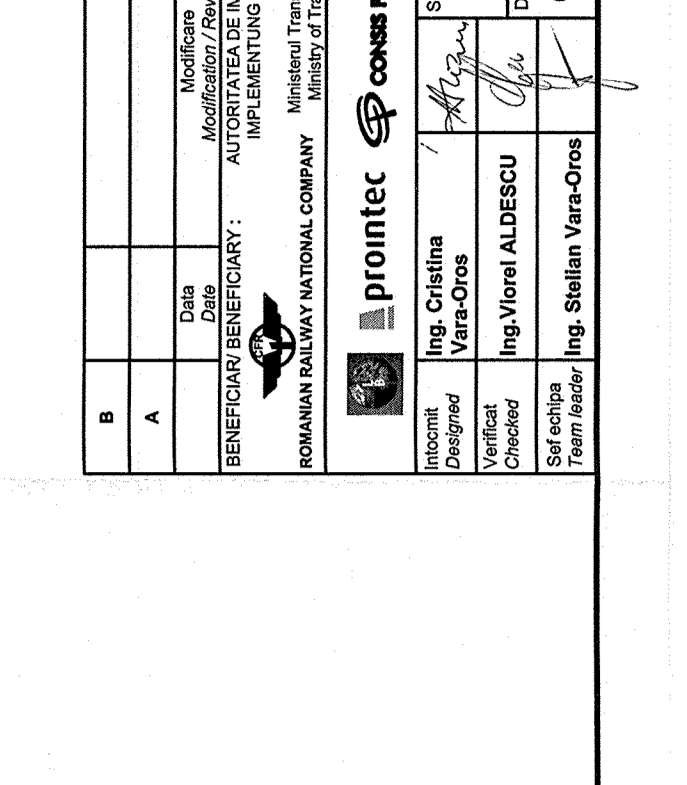
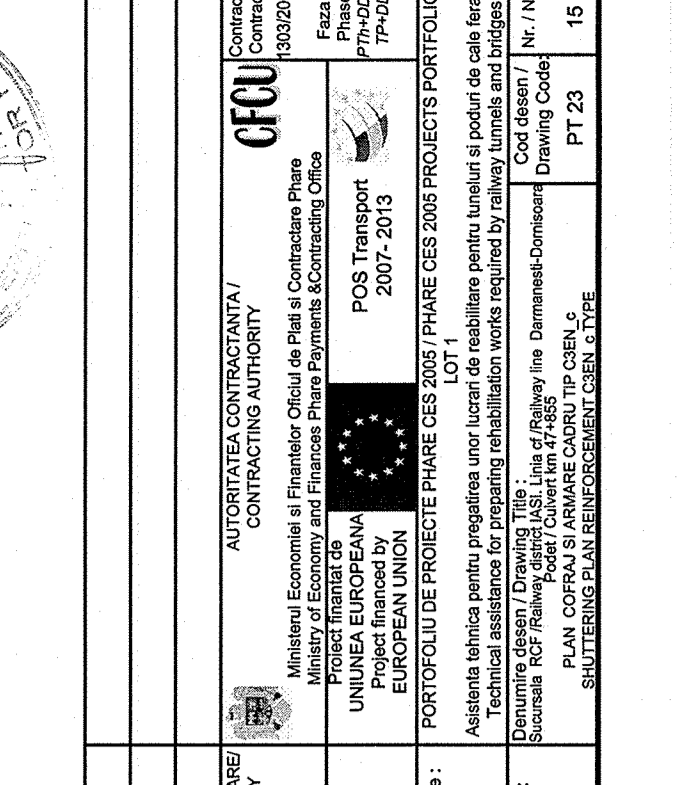
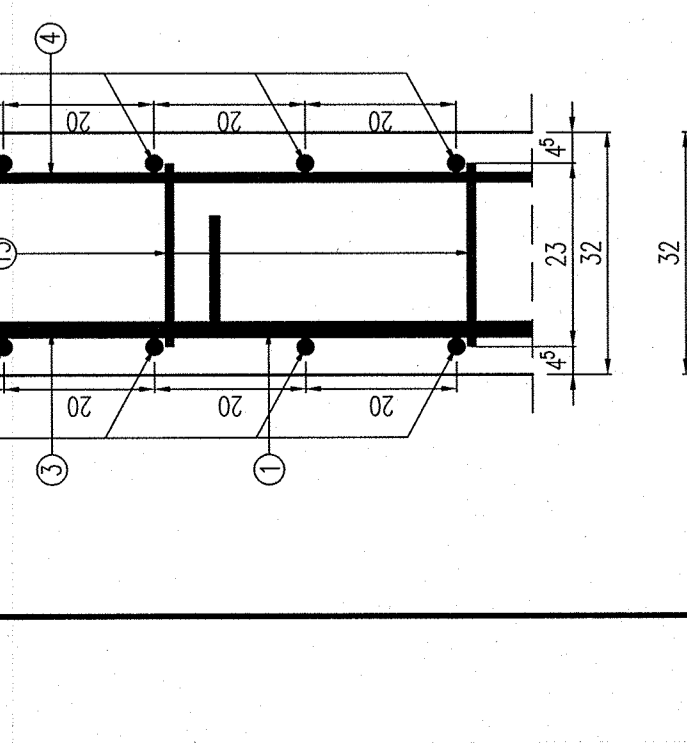
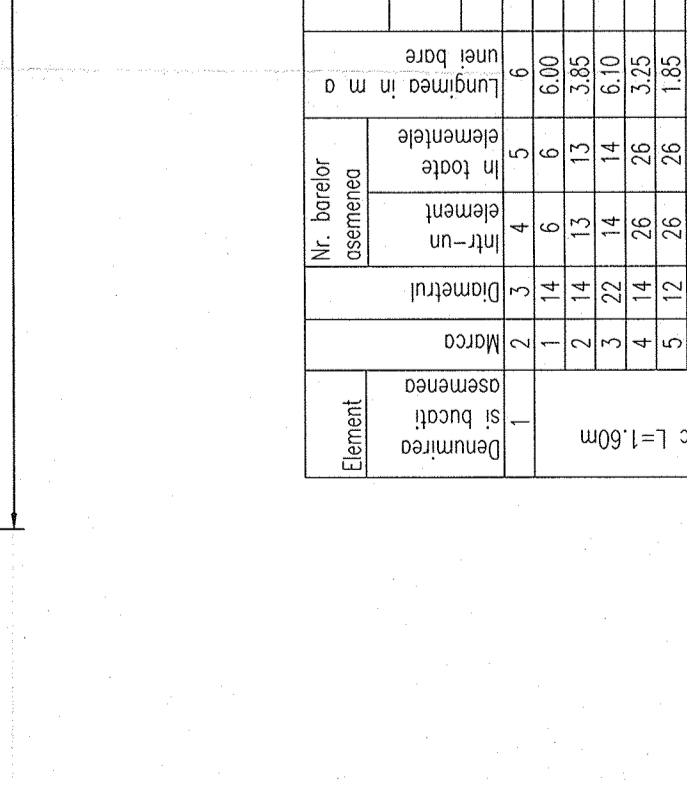
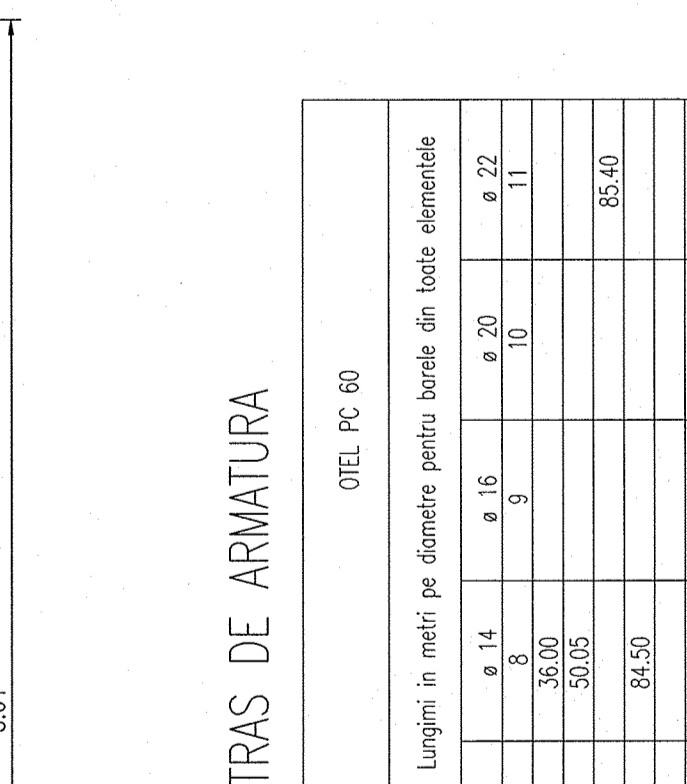
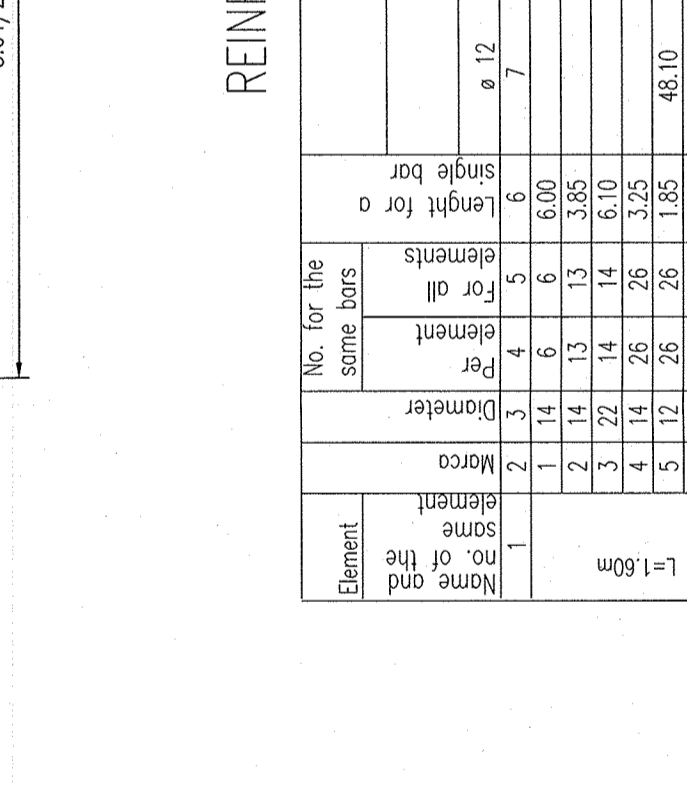
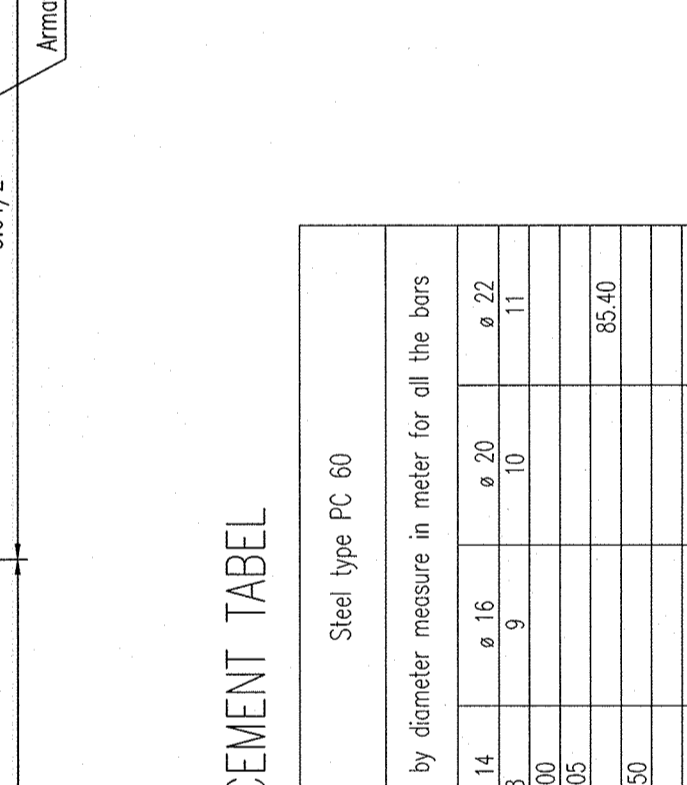
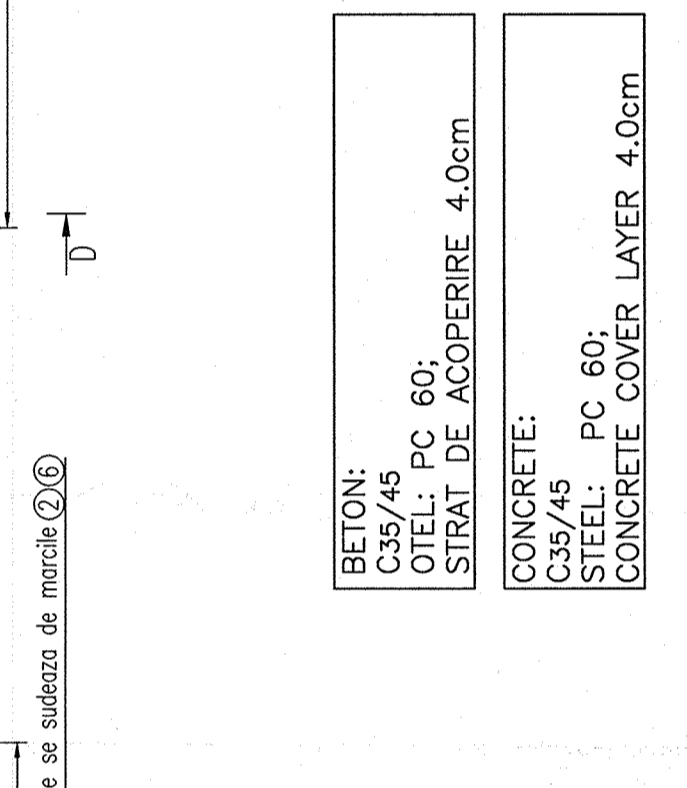
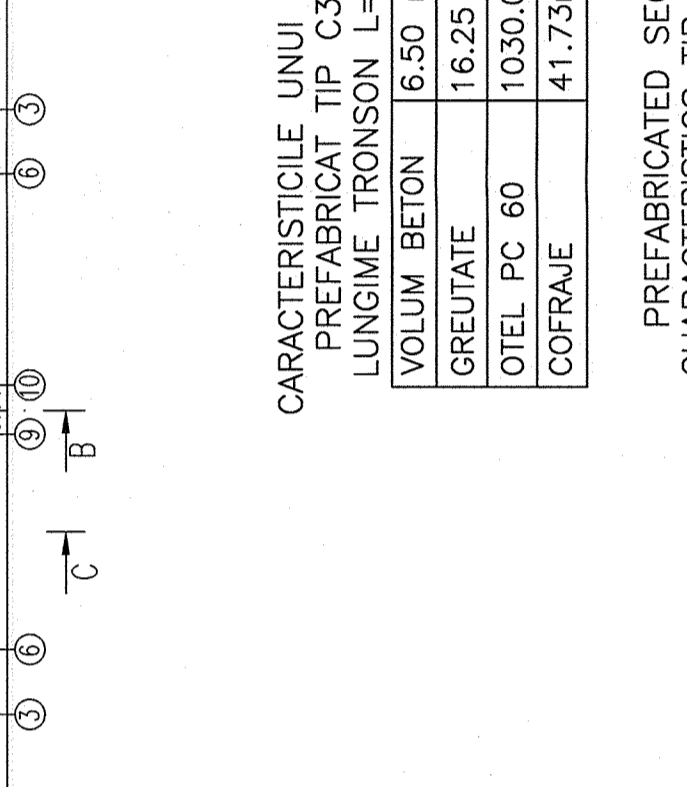
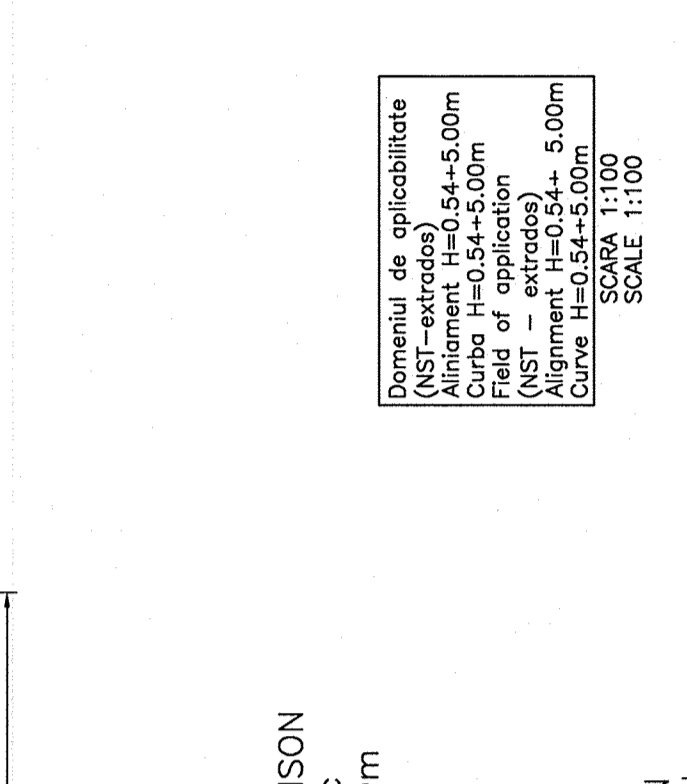
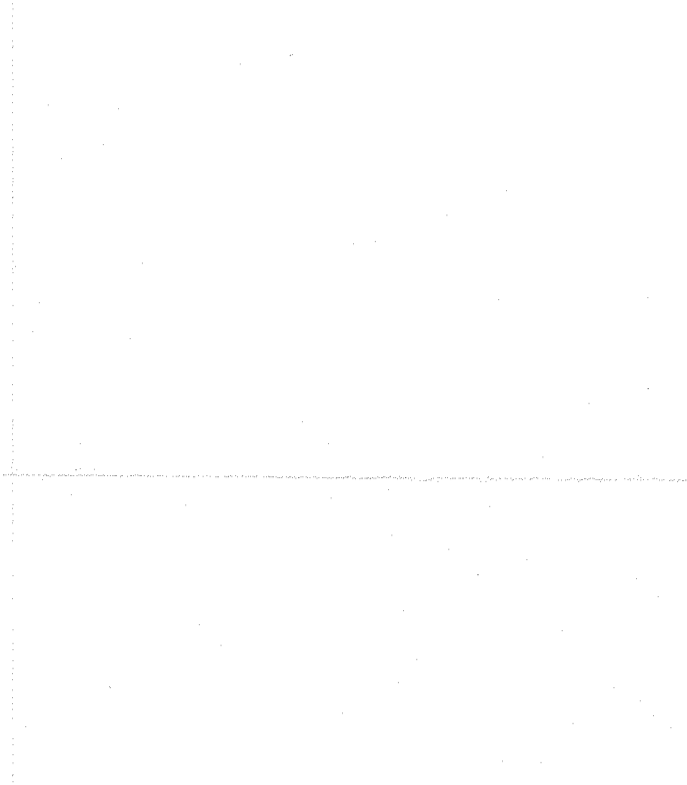
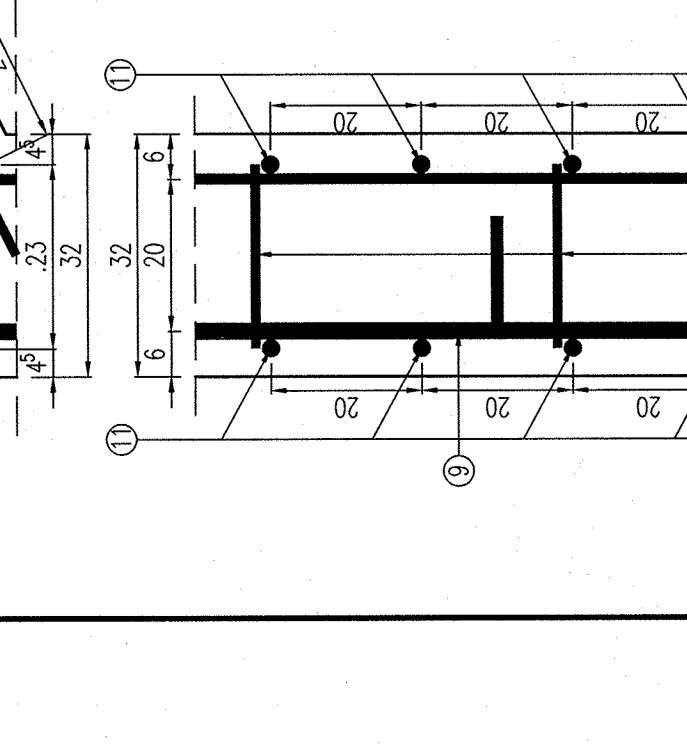
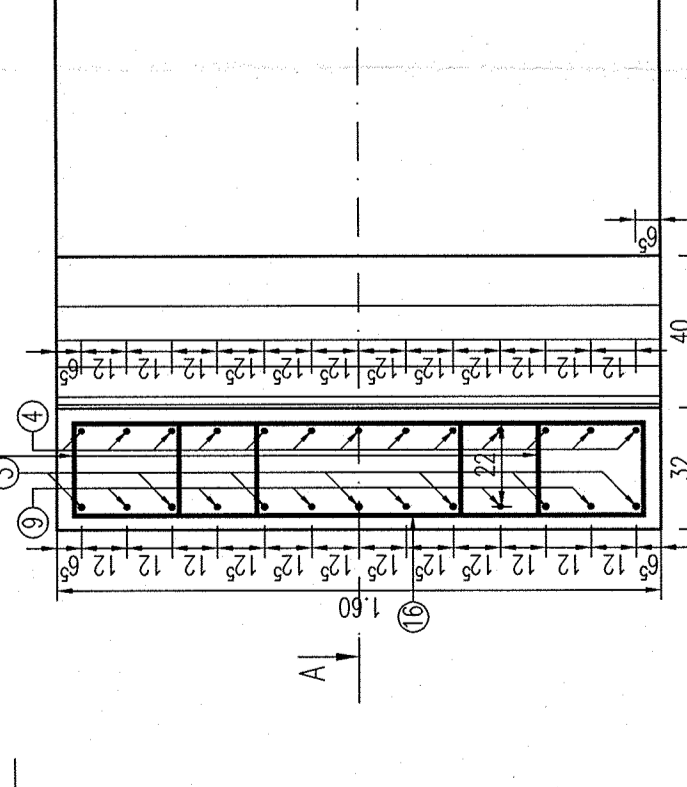
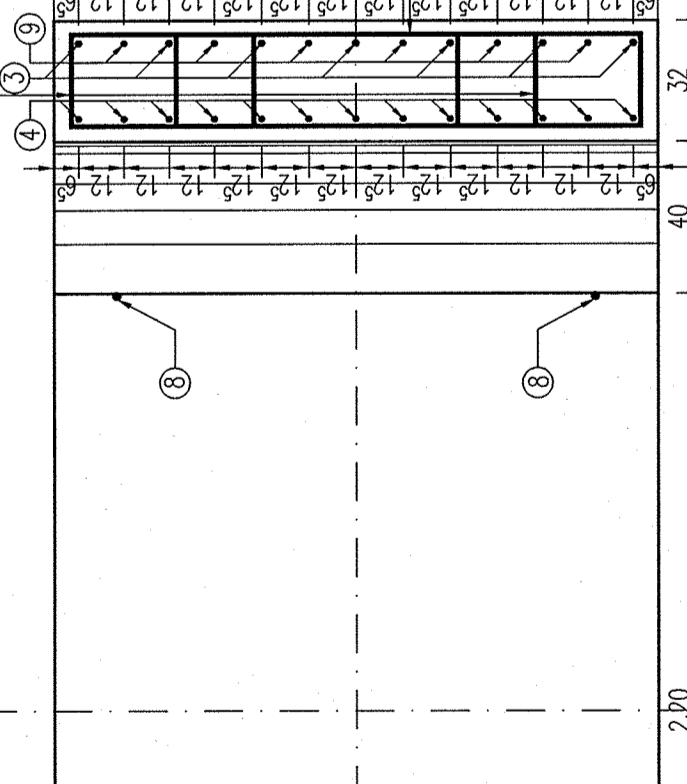
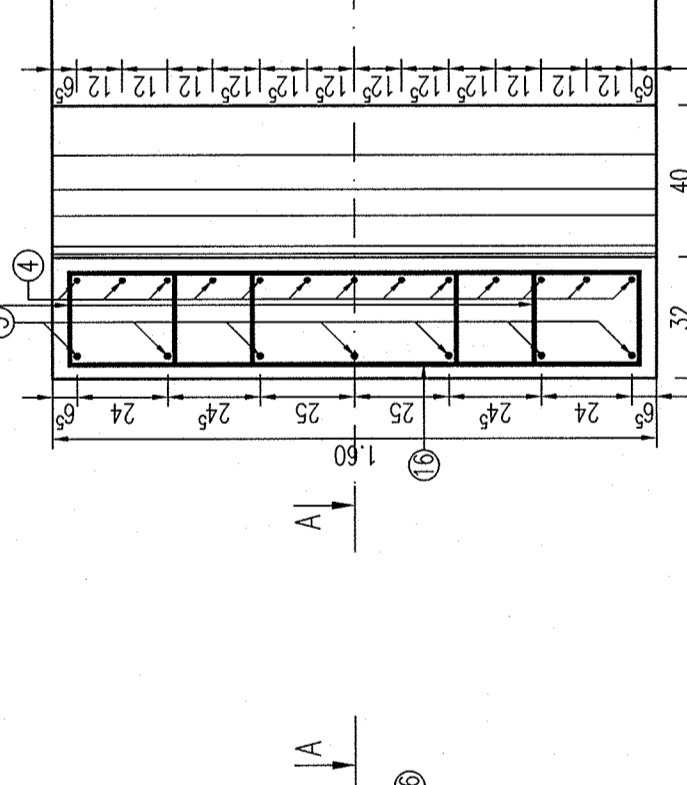
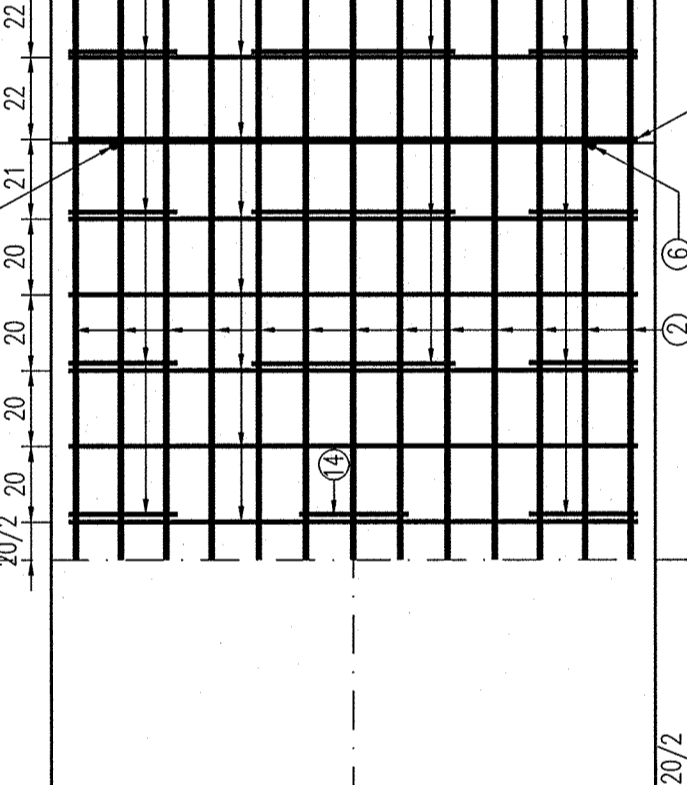
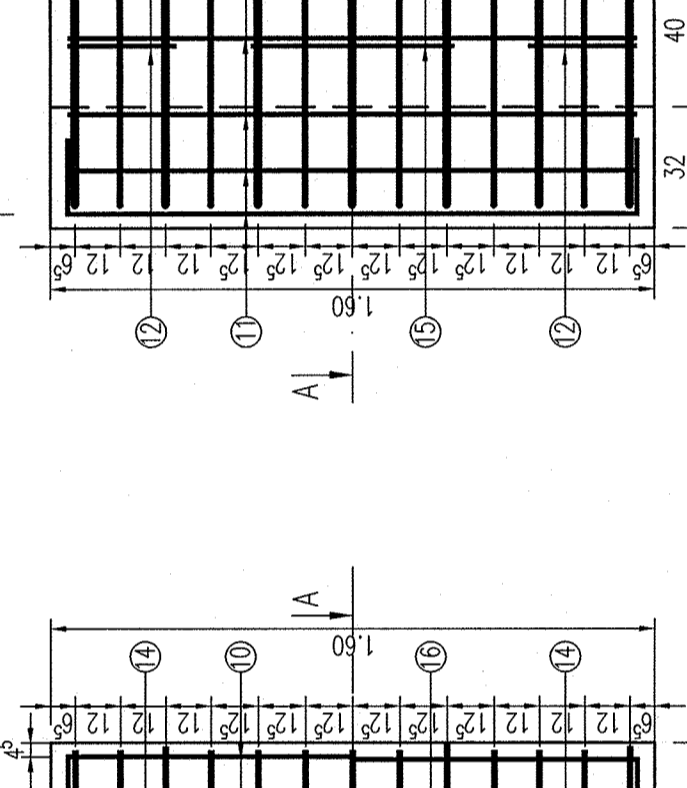
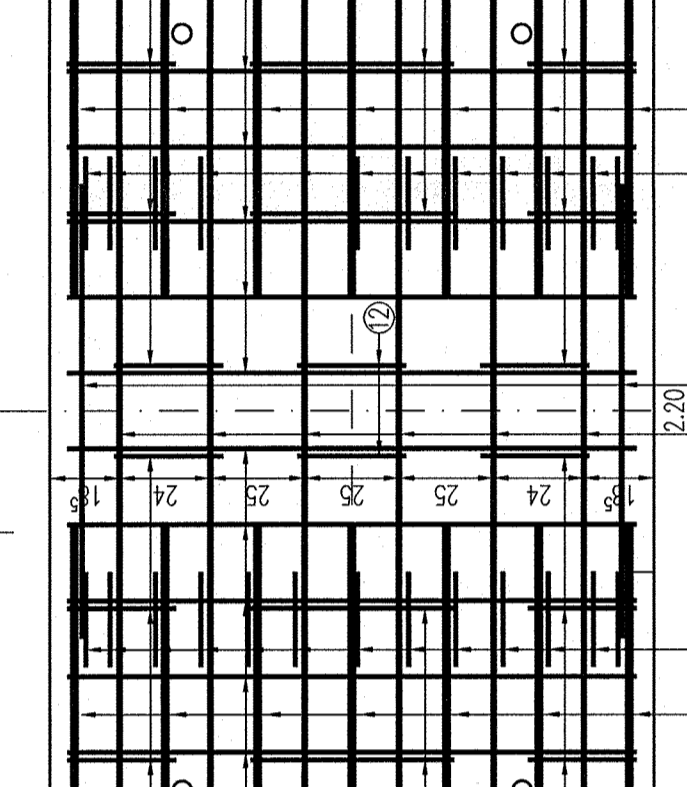
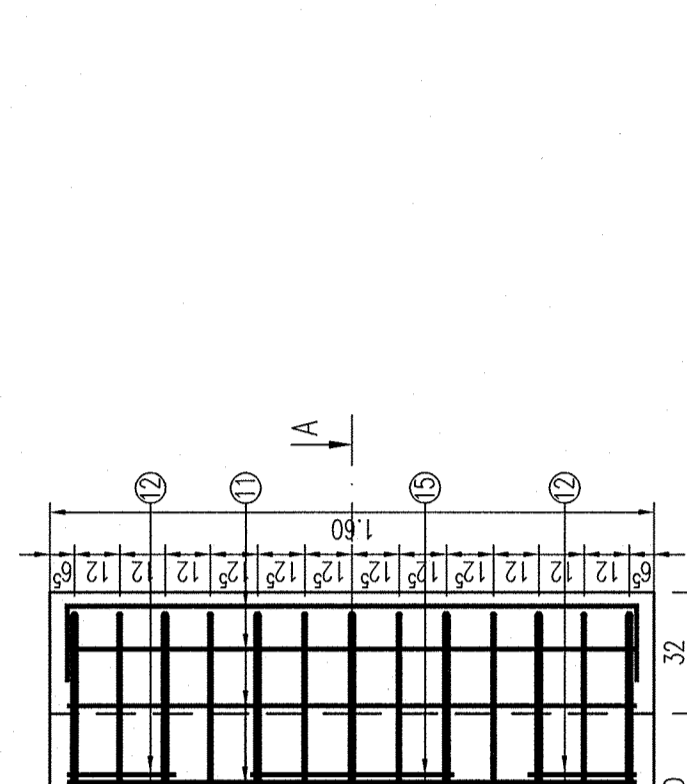
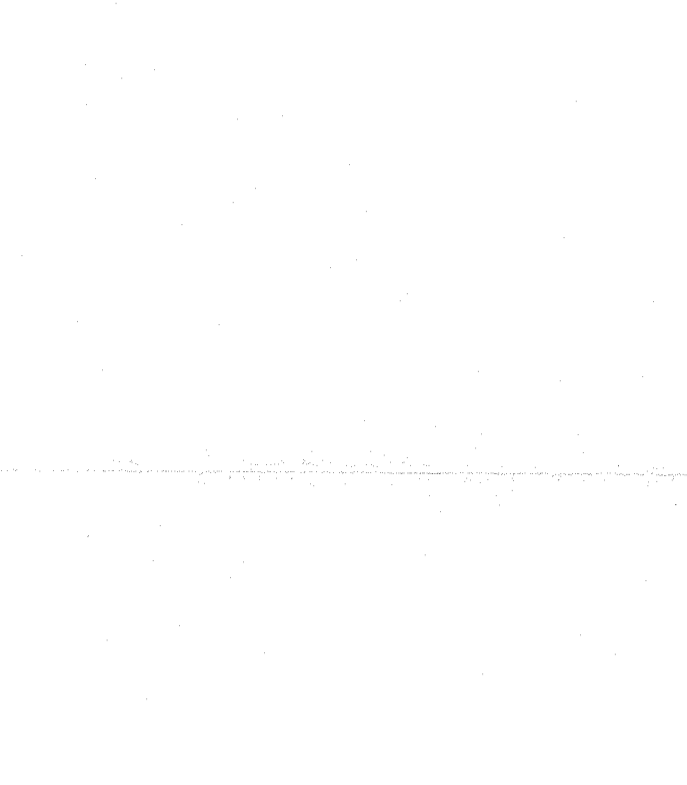
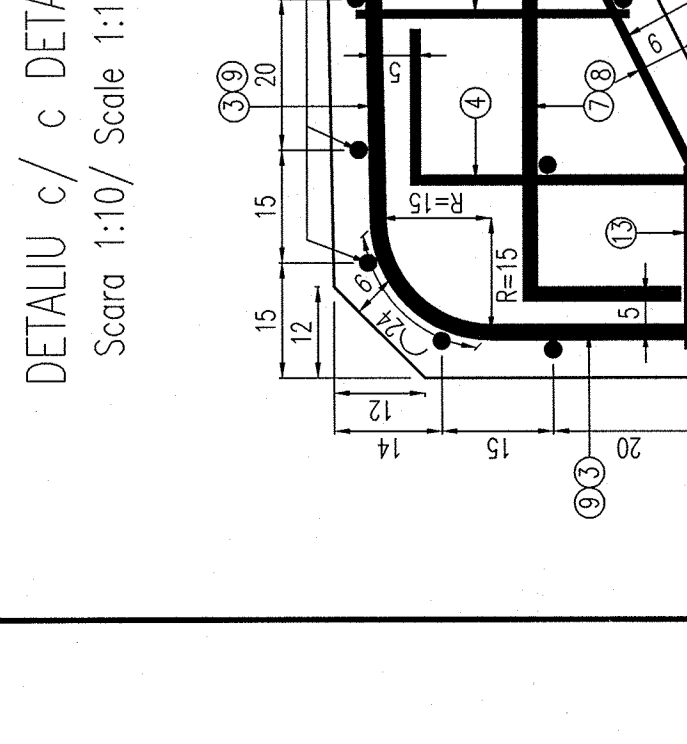
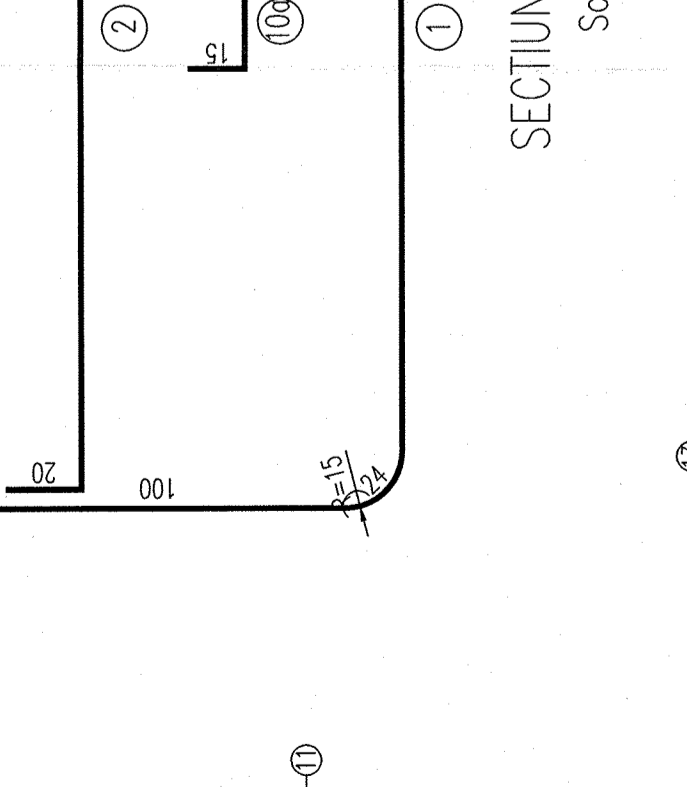
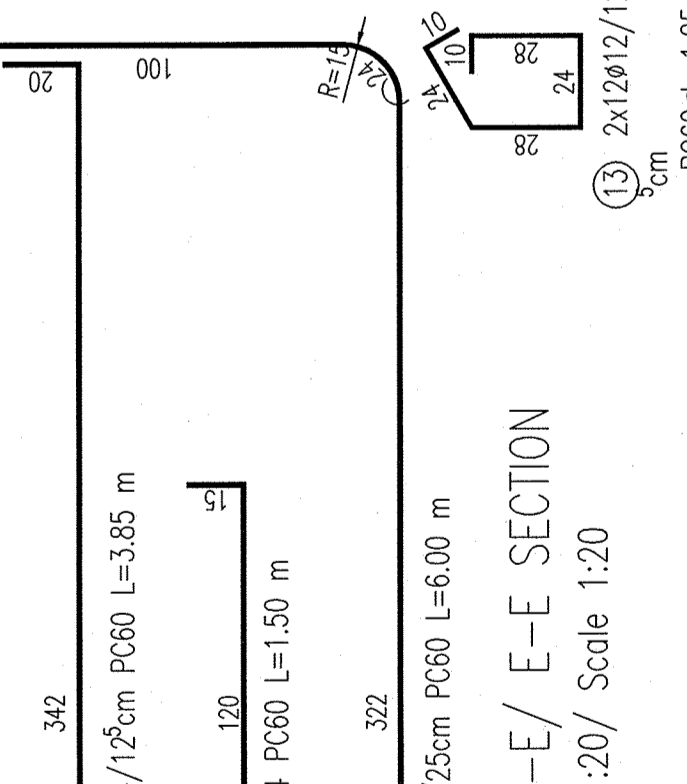
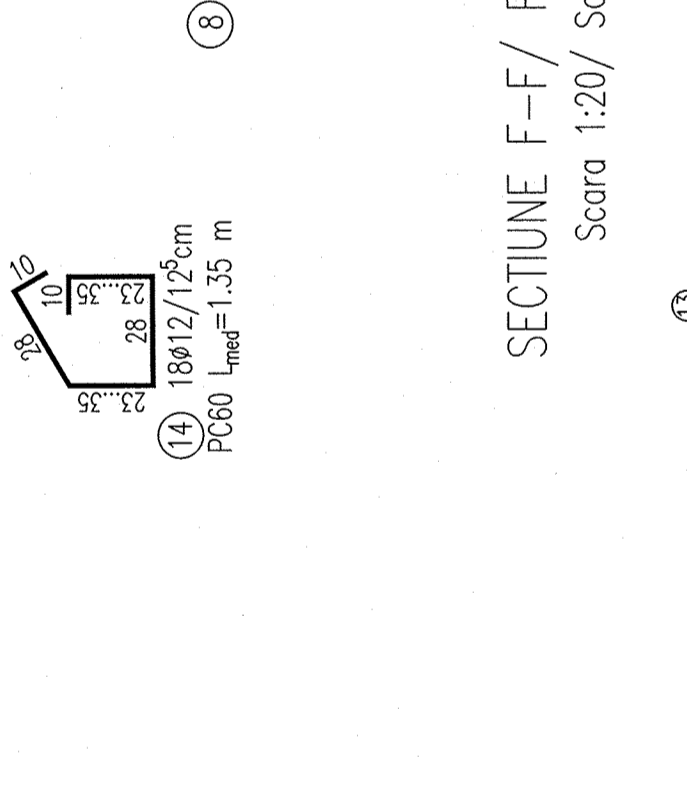
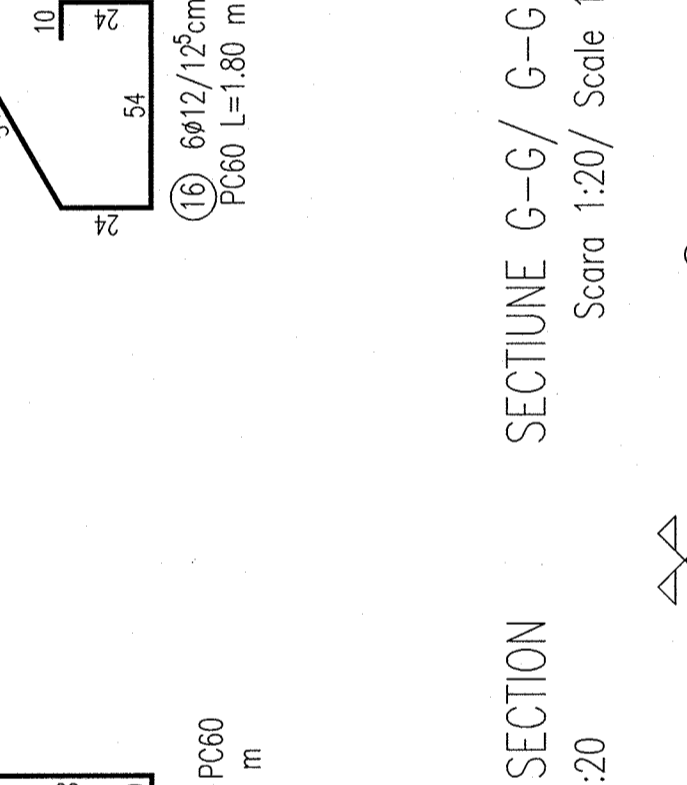
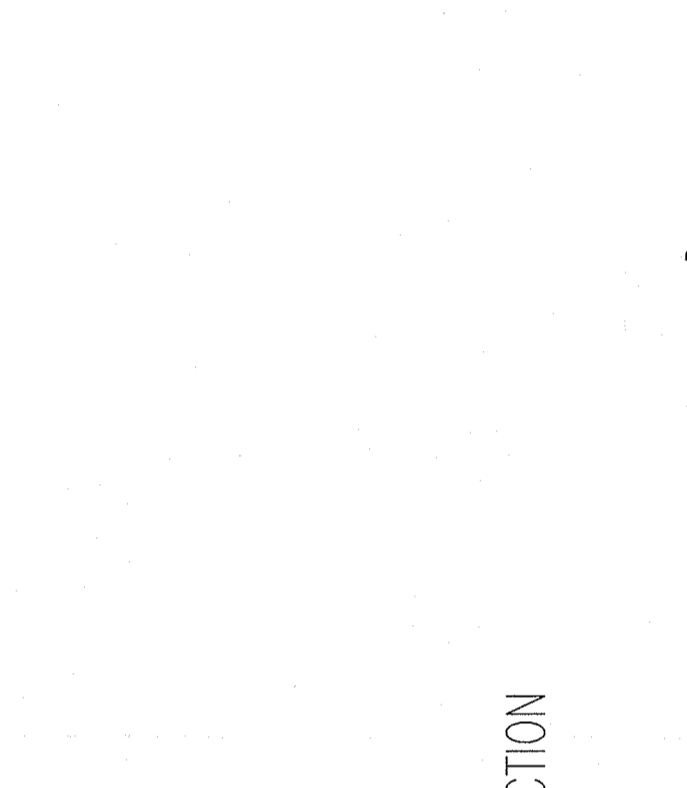
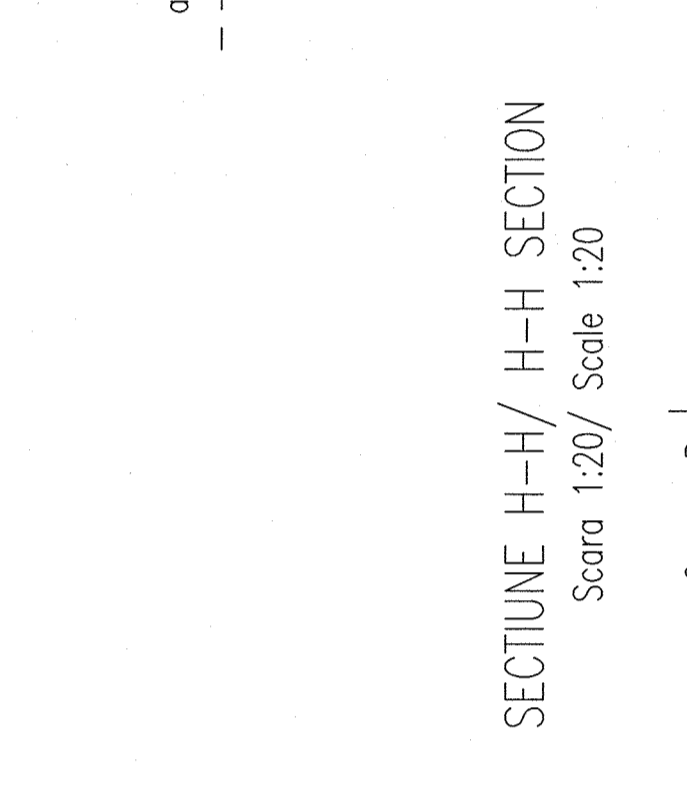
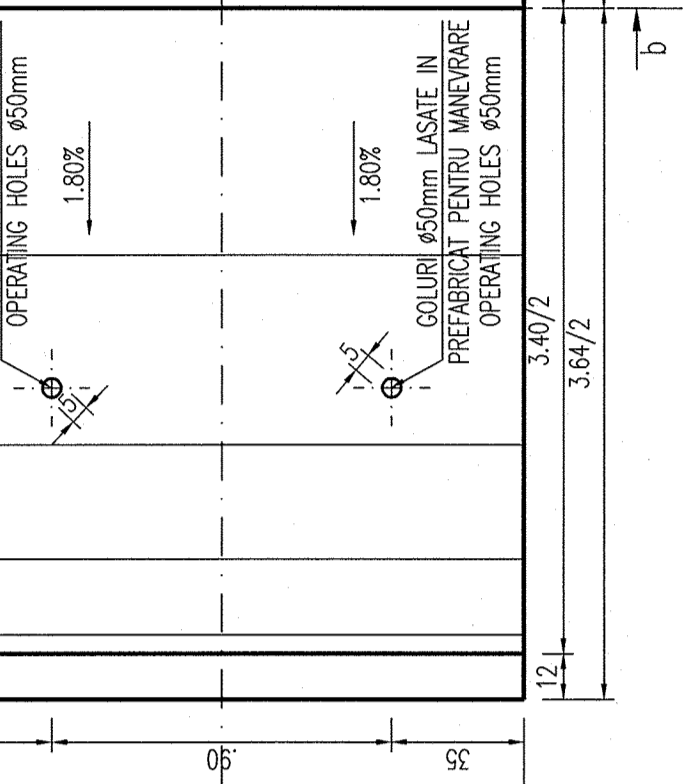
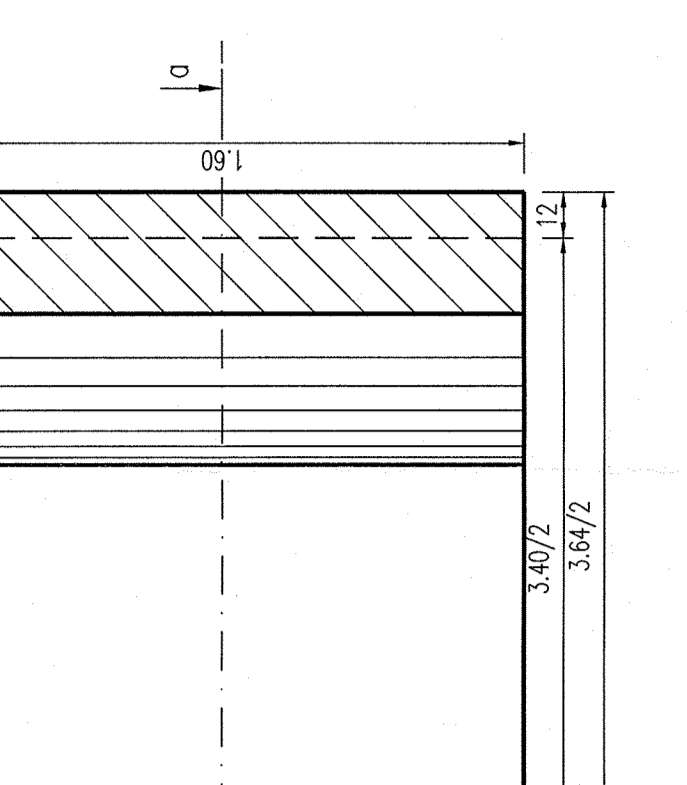
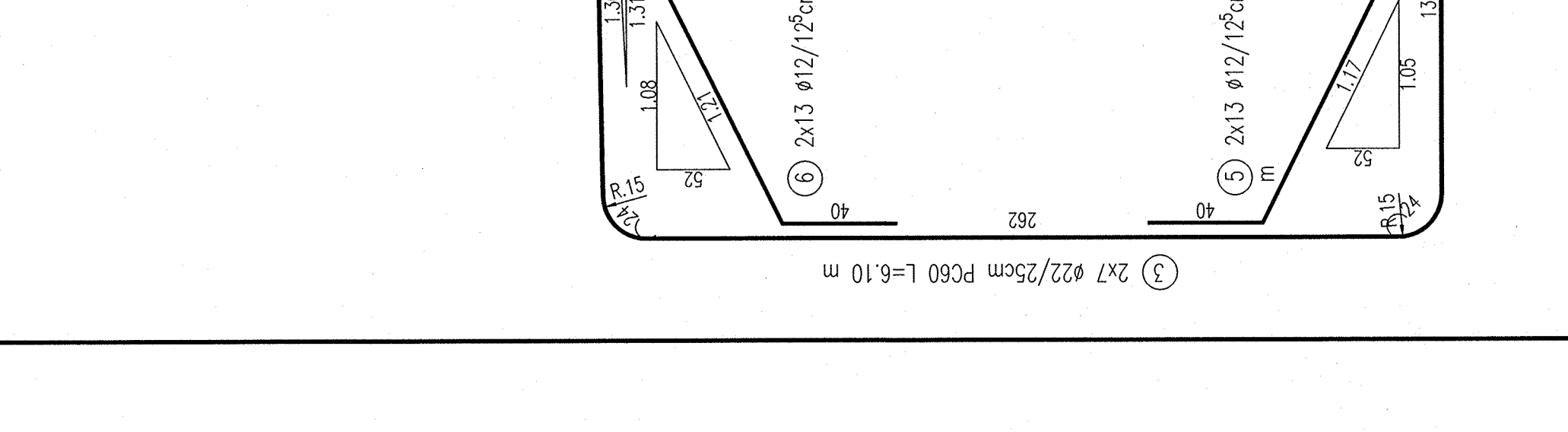

REINFORCEMENT TABLE

EXTRAS DE ARMATURA

CHARACTERISTICE UNUI TRONSON
PREFABRICAT TIP C3EN_c
LUNGIME TRONSON L=1.60m

CHARACTERISTICE UNUI TRONSON
PREFABRICAT TIP C3EN_c
LUNGIME TRONSON L=1.60m

CHARACTERISTICE UNUI TRONSON
PREFABRICAT TIP C3EN_c
LUNGIME TRONSON L=1.60m

CHARACTERISTICE UNUI TRONSON
PREFABRICAT TIP C3EN_c
LUNGIME TRONSON L=1.60m

CHARACTERISTICE UNUI TRONSON
PREFABRICAT TIP C3EN_c
LUNGIME TRONSON L=1.60m

CHARACTERISTICE UNUI TRONSON
PREFABRICAT TIP C3EN_c
LUNGIME TRONSON L=1.60m

CHARACTERISTICE UNUI TRONSON
PREFABRICAT TIP C3EN_c
LUNGIME TRONSON L=1.60m

CHARACTERISTICE UNUI TRONSON
PREFABRICAT TIP C3EN_c
LUNGIME TRONSON L=1.60m

